



**Fund for Lake Michigan**  
Clearly making a deep impact.



**FINAL REPORT**  
**Greenprint-Milwaukee Shoreline Vision Plan**  
**April 2017**



**The Sigma Group, Inc.**  
1300 W. Canal Street  
Milwaukee, WI 53233  
(414) 643-4200

Email: [rpeschel@thesigmagroup.com](mailto:rpeschel@thesigmagroup.com)



**SEH, Inc.**  
159 N. Jackson Street #106  
Milwaukee, WI 53225  
(608) 977-0817  
Email: [efreer@sehinc.com](mailto:efreer@sehinc.com)



**Stormwater Solutions Engineering LLC**  
247 Freshwater Way, Suite 410  
Milwaukee, WI 53204  
(414) 810-1245  
Email: [cbg@stormwatersolutions.co](mailto:cbg@stormwatersolutions.co)



## TABLE OF CONTENTS

---

|    |  |           |
|----|--|-----------|
| 1. | <b>INTRODUCTION</b>                                      | <b>1</b>  |
| 2. | <b>EXISTING CONDITIONS</b>                               | <b>3</b>  |
|    | 2.1 Site Features  | 3         |
|    | 2.2 Access and Connections                               | 5         |
|    | 2.3 Water's Edge   | 7         |
|    | 2.4 Stormwater   | 8         |
|    | 2.5 Historical Geotechnical Evaluation                   | 8         |
|    | 2.6 Infrastructure                                       | 9         |
|    | 2.7 Programmatic Objectives                              | 10        |
| 3. | <b>STAKEHOLDER AND PUBLIC INPUT</b>                      | <b>12</b> |
|    | 3.1 User/Interested Group Identification                 | 12        |
|    | 3.2 Stakeholder Meeting #1                               | 12        |
|    | 3.3 Design Workshop                                      | 12        |
|    | 3.4 Stakeholder Meeting #2                               | 15        |
|    | 3.5 Focus Group Meetings                                 | 14        |
|    | 3.6 Public Meeting                                       | 15        |
| 4. | <b>STORMWATER BMP EVALUATION</b>                         | <b>17</b> |
|    | 4.1 Site-wide Stormwater Management/Green Infrastructure | 17        |
|    | 4.2 North Parking Lot Improvements (Phase I)             | 19        |
| 5. | <b>VISION PLAN</b>                                       | <b>20</b> |
|    | 5.1 Vision Plan Aspects                                  | 20        |
|    | 5.2 Funding Opportunities                                | 23        |
| 6. | <b>NORTH PARKING LOT CONCEPTUAL PLAN</b>                 | <b>24</b> |
|    | 6.1 Parking Lot Configuration Alternatives               | 24        |
|    | 6.2 Operation and Maintenance                            | 24        |
|    | 6.3 Cost Projection                                      | 25        |

## **FIGURES**

1. Existing Site Utilities
2. Topography and Storm Sewer System
3. Greenprint for Milwaukee Shoreline-Phase 1 Details
4. Parking Concept A
5. Parking Concept A – Pedestrian Connections
6. Parking Concept A.2 – Pedestrian Connection
7. Phase 1 – Concept B
8. Phase 1 – Concept C
9. Rendering – Looking South-West
10. Rendering – Looking North along promenade
11. Rendering – Looking East from bluff

## **APPENDICES**

- A. Stakeholder List
- B. Workshop Outcome
- C. Stakeholder Meeting #2 Notes

## **ACKNOWLEDGMENTS**

### Steering Committee

|                |                                      |
|----------------|--------------------------------------|
| Julie Bastin   | Milwaukee County DAS                 |
| Vicki Chappell | Milwaukee County War Memorial Center |
| David Drent    | Milwaukee County War Memorial Center |
| Kevin Haley    | Milwaukee County Parks               |
| Mary McCormick | Rotary Club of Milwaukee             |
| Phil Schultz   | Horizon/Rotary Club of Milwaukee     |
| Jane Wochos    | Milwaukee Art Museum                 |

### Planning Consulting Team

The Sigma Group, Inc. (Sigma)  
Short Elliott Hendrickson, Inc. (SEH)  
Stormwater Solutions Engineering, LLC (SSE)



## COMPENDIUM (USB flash drive Provided)

1. Development of Parking Lot Ideas
  - a. Parking Options (2016-10-27)
  - b. Milwaukee DCD Idea
  - c. Phil's Idea
2. Downtown Milwaukee Projects and Events
  - a. 2016 Downtown Milwaukee Area Investment Map
  - b. 2016 Lakefront Events
  - c. Gateway Project Overview
  - d. Gateway Project Multiuse Trail Connections
  - e. Gateway Project Preferred Alternative
  - f. Gateway Project Presentation – Milwaukee DCD
3. Field Observations and Aerial Photos
  - a. Field Observations (2016-07-19)
  - b. Aerial Photos
4. Geotechnical Reports
  - a. Veterans Park Shelter Geotechnical Report (2012-07-09)
  - b. Art Museum Addition Geotechnical Report (2013-10-18)
5. Grant Applications
  - a. Fund for Lake Michigan 2017 Spring cycle
  - b. MMSD 2017 Green Infrastructure Partnership Program
  - c. National Fish and Wildlife Foundation - Sustain Our Great Lakes 2017
6. Historic Site Plans
  - a. Parking Lot Survey-30 x 42 Plan
  - b. Survey Base-C100 Site Plan
  - c. Survey Base-C101 Site Plan
  - d. Survey Base-Future Road Improvement
7. Lake Michigan
  - a. Lakes Michigan-Huron Water Levels – August 2016
  - b. No Wake Zone
8. Lincoln Memorial Drive
  - a. Reconfiguration Drawing – Julie
  - b. Turning Study
9. MacArthur Statue
  - a. Landscape Plan
  - b. Photos
  - c. Request for Review
10. Meeting Minutes
  - a. 2016-06-21
  - b. 2016-07-05
  - c. 2016-07-14
  - d. 2016-07-19
  - e. 2016-08-16
11. Notifications
  - a. Public Notice (2016-07-11)
  - b. Public Notice (2016-09-28)
  - c. Stakeholder Meeting #1 (2016-07-14)
  - d. Stakeholder Meeting #2 (2016-09-29)
12. Presentations
  - a. Stakeholder Meeting #1(2016-07-14)
  - b. Steering Committee Meeting – Draft Master Plan (2016-10-25)
  - c. Public Meeting (2017-03-14)
13. Previous Veterans Park Planning Ideas
  - a. Birdseye to South
  - b. Gathering Place
  - c. Gathering Place from Bridge Path
  - d. Pavilion from the Green
14. Progress Report – January 31, 2017
15. Public Meeting
  - a. Public Meeting Sign-in Sheet
  - b. Public Meeting Press Release
16. Veterans Park Concept Ideas
  - a. Alternative Alpha
  - b. Alternative Bravo
  - c. Alternative Charlie
17. Grants and Cost Projections
  - a. 20-year Vision Plan Cost Projections
  - b. Grants and Awards

# 1. INTRODUCTION

The War Memorial Center (WMC) in cooperation with Milwaukee County (County), the Milwaukee Art Museum (MAM), the Rotary Club of Milwaukee (Rotary) and the Milwaukee Metropolitan Sewerage District (MMSD) undertook the development of a vision planning effort funded by a \$75,000 grant from the Fund for Lake Michigan. The planning consulting team (planning consultant) composed of The Sigma Group, SEH, and Stormwater Solutions Engineering, with input from UWM School of Architecture & Urban Planning's James Wasley was retained to complete a Vision Plan along Lake Michigan near downtown shoreline in Milwaukee, WI. The focused shoreline project area stretches from the northern border of the planned Milwaukee Gateway Project, north through Milwaukee County Veterans' Parks to McKinley Marina. The project area is outlined in red.

Named "Greenprint-Milwaukee Shoreline Vision Plan", the intent was to formulate a plan with sustainable design elements for current and future projects along Milwaukee County's shoreline. A primary goal was to enhance circulation systems and reduce conflict among vehicles, pedestrians, bikers, and other park users with landscaping, multi-use trails, and parkland features to enhance recreational and ecological uses of this prime location along the lakefront as well as to consider future opportunities for public art, memorials, monuments honoring Veterans and other civic leaders.

The significant focus of the plan was to provide recommendations for incorporating green infrastructure (GI) components to improve water quality and the ecology of the near shore land interface with Lake Michigan given the lake is a most valuable natural resource to Milwaukee, Wisconsin and the Great Lakes region. GI addresses the impacts of run-off from Lincoln Memorial Drive, WMC and Veteran's Park surface pavements discharging to the Veterans Park lagoon and Lake Michigan as well as enhances habitat, bird and insect flyways that can be incorporated into the park setting honoring the traditions and thoughtful design features of the Milwaukee County Parks.



Green Infrastructure has become a community goal and a priority nationwide and in our region. The Greenprint project area is located in the Milwaukee Metropolitan Sewerage District (MMSD) boundaries. In its 2035 Vision and Strategic Objectives, the MMSD states that capturing the first 0.5-inch of rainfall using GI is one of its integrated watershed management objectives. In the City of Milwaukee's sustainability plan, *ReFresh Milwaukee*, a key objective is to increase the volume of stormwater captured using GI by 10% annually. Preserving Lake Michigan as a resource and the use of GI are important aspects to Milwaukee positioning itself as a global center for water innovation.

Current infrastructure initiatives dealing with stormwater management, protecting the coastal waters, green port Initiatives and the goals of the region embrace the integration of green infrastructure. Whether pragmatic or economically driven, this approach is a sustainable and holistic approach with the following benefits:

## **Ecological**

- Water Quality
- Water Conservation
- Habitat Enhancement
- Lakefront Design Feature
- Ecological Sustainability
- Stewardship of Lake Michigan

## **Economic**

- Local and Tourist Destination Appeal
- Catalyst for Downtown Investment
- Support of Institutional Campus
- Eco-tourism
- Economic Sustainability

## **Cultural, the Public Realm & Urban Design**

- Place Making
- Publicly Accessible Lakefront
- Open Space Design
- Lakefront Connectivity
- Educational / Interpretive Communication
- Community Wellness

Green Infrastructure functions as a regional solution serving a variety of land uses like the Museum Campus, the Gateway Project, the adjacent downtown business district, and residential neighborhoods; and becomes a foundation promoting community wellness. Strictly from a site engineering perspective it is an innovative alternative to pipes and pavements. The approach pushes creativity in the development of new materials, higher use of pervious materials, responsible use of native plantings and best management practices in stormwater management. Sustainable and economic impacts are realized through long term cost savings, operational efficiencies and management benefits. The largest and most obvious benefit is the interface with the Lake. The result is an awareness, the conservation and stewardship of one of the State’s most valuable natural resources, Lake Michigan.

The planning effort involved reviewing existing conditions documents, conducting site observations, considering multi-uses of the project area (art fairs, run/walks, firework, Veterans Park events), and ongoing recreational and related public activities, identifying stormwater Best Management Practices (BMPs), and illustrating recommendations into a conceptual design Vision Plan. Significant input through interaction with Steering Committee, stakeholders, and public was solicited as presented in the project schedule. The stakeholders participated in several listening sessions and a design workshop. A public meeting was held at the War Memorial Center to present the conceptual design and collect feedback.

A Vision Plan for the project area along with a more detailed concept for the WMC North Parking Lot, as an initial phase, and cost estimate were developed as the outcome of the planning process. The emphasis of the initial phase is to reconfigure the North Parking Lot incorporating GI while creating an easily identified, inviting natural and appealing entry to the War Memorial Centers’ north entrance. The major activities associated with the planning effort are presented as a schedule in this section.

**Greenprint  
Milwaukee Shoreline Vision Plan**

Revised Schedule: April 2017

| Task   | June | July | August | September | October | November | December | January | February | March | April |
|--|------|------|--------|-----------|---------|----------|----------|---------|----------|-------|-------|
| Review Existing Documents  | █    | █    |        |           |         |          |          |         |          |       |       |
| Bi-Weekly Steering Committee Meeting<br><small>6/21, 7/5, 7/19, 8/2, 8/16, 8/30, 9/13, 9/26, 10/20, 11/3</small> | █    | █    | █      | █         | █       | █        | █        |         |          |       |       |
| Collect Stakeholder Input  |      | █    | █      | █         | █       | █        | █        | █       | █        | █     |       |
| Stakeholder Meeting 1<br><small>July 14, 2016</small>  |      | █    |        |           |         |          |          |         |          |       |       |
| Detailed Site investigation  |      | █    | █      |           |         |          |          |         |          |       |       |
| Identify Site Uses   |      | █    | █      |           |         |          |          |         |          |       |       |
| Identify BMPs  |      | █    | █      |           |         |          |          |         |          |       |       |
| Workshop<br><small>September 14, 2016</small>  |      |      |        | █         |         |          |          |         |          |       |       |
| Develop Conceptual Design  |      |      | █      | █         |         |          |          |         |          |       |       |
| Stakeholder Meeting 2<br><small>September 29, 2016</small>   |      |      |        | █         |         |          |          |         |          |       |       |
| Refine Conceptual Design   |      |      |        | █         | █       | █        | █        | █       | █        | █     |       |
| Progress Report<br><small>November 7, 2016</small>   |      |      |        |           |         | █        |          |         |          |       |       |
| County Parks Committee Agenda Notice<br><small>November 8, 2016</small>  |      |      |        |           |         | █        |          |         |          |       |       |
| Final Grant Report to FFLM<br><small>February 21, 2017</small>   |      |      |        |           |         |          |          |         | █        |       |       |
| Touch-base with Outstanding Stakeholders   |      |      |        |           |         |          |          |         | █        | █     |       |
| County Parks Committee Buy-in<br><small>December 6, 2016</small>   |      |      |        |           |         |          | █        |         |          |       |       |
| County Authority for Grant Application   |      |      |        |           |         |          | █        |         |          |       |       |
| Grant Application Deadline - MMSD  |      |      |        |           |         |          |          |         | █        |       |       |
| Grant Application Deadline - Fund for Lake Michigan  |      |      |        |           |         |          |          |         | █        |       |       |
| Public Meeting<br><small>March 14, 2017</small>  |      |      |        |           |         |          |          |         |          | █     |       |
| Generate Final Draft Report  |      |      |        |           |         |          |          |         | █        | █     |       |
| Final Report<br><small>Received comments due</small>   |      |      |        |           |         |          |          |         |          |       | █     |



## 2. EXISTING CONDITIONS

### 2.1 Site Features and Uses

The project area consists of nearly 3 miles of Milwaukee's shoreline bounded by Michigan Avenue and adjacent to the future Milwaukee Gateway at the south, Lincoln Memorial Drive on the west along Lake Michigan shoreline to the County's McKinley Marina to the north. This area consists of land occupied by the War Memorial Center and the Milwaukee Art Museum, and includes Milwaukee County Veterans Park. The existing conditions are a blend of park and institutional campus and is a very popular destination for recreators, tourists, art lovers, etc. The area is well loved, well used, and looking tired.

Veterans Park features the Southeastern Wisconsin Vietnam Veterans Memorial, the lagoon including paddle craft rental operations, the Milwaukee Community Sailing Center, segments of the Oak Leaf Trail, a network of multi-use trails, a large grassy open space, the Old Coast Guard Pavilion area, assorted concession operations, several park buildings and surface parking lots that support the marina.



Park Sign



Vietnam Veterans Memorial





Lagoon paddle craft rentals



Rental Concessions



Concessions



Tired park bench at Veterans Park



Milwaukee Community Sailing Center



New Coast Guard Pavilion



MacArthur Statue



Multi-use trail along the lagoon and LMD

**2.2 Access and Connections**

The parking area north of the WMC serves as the main entrance to the Center, the new east wing addition to the MAM, access to the underground loading dock for the MAM as well as the parking and loading dock for the WMC under the Mason Street bridge and ramp. Currently, there are three individual asphalt parking lots that serve both the War Memorial Center and the Milwaukee Art Museum regular business and functions. The existing parking lots are deteriorated, resulting in additional sediment and associated pollutants washing into the storm sewer during precipitation. The storm sewer for the north lots drains directly to Lake Michigan.

The configuration of Lincoln Memorial Drive at the intersection with the Mason Street Bridge ramp and the North Parking Lot is problematic at best and during heavy traffic, difficult for motorized vehicles to efficiently navigate. With no controlled intersection, the north bound downhill Mason Street Bridge ramp merging with Lincoln Memorial Drive functions like a freeway on-ramp that is prone to speeds exceeding the 30-mph limit. With the speed and traffic patterns for vehicles, this intersection is also unsafe and difficult for pedestrians and bicyclists to navigate both crossing and along Lincoln Memorial Drive. Pedestrian and bike at grade crossings of four lanes of traffic connecting the Oak Leaf Trail on the westside of the parkway with the lakefront side is challenging. An undeveloped trail has been established along the east side of Lincoln Memorial Drive running from the MAM south area and under the Mason Street Bridge north.

There are opportunities to reconfigure North Parking Lot parking proximity to shoreline by creating green space buffer, improve access connections including to south of project area with the future Milwaukee Gateway, reduce vehicular/bike/pedestrian conflicts, soften the visual impact of parking and road, and improve the sense of arrival to the WMC/MAM.



“Lot A”

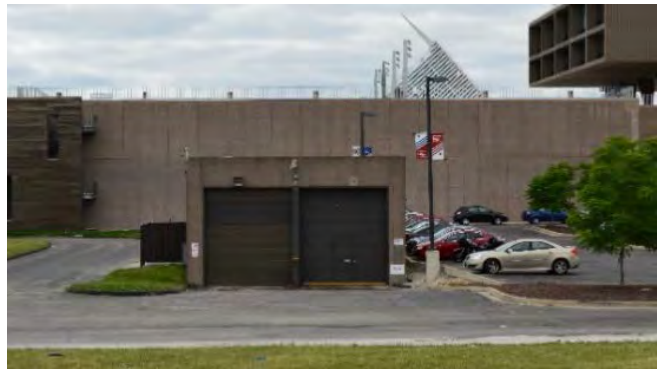

MAM Loading Dock Access



WMC Front Entrance



New MAM East Addition Entrance





Lincoln Memorial Drive and Ramp



Mason Street Bridge Ramp looking North



Bike/Pedestrian Crossing



Brady Street Bridge

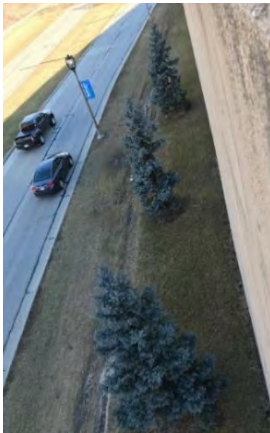

Undeveloped Trail along LMD



Multi-use Trail Crossing at Parking Lot Entrance



War Memorial Center Hidden Entrance

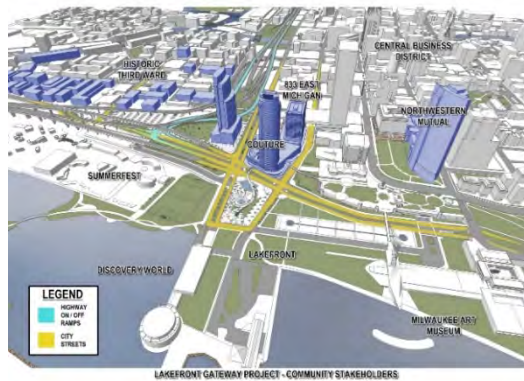

Milwaukee Gateway Rendering

### 2.3 Water's Edge

The facilities within the site at the Water's Edge include the tree lined concrete promenade featuring stainless steel railing and concrete benches in front of the MAM/WMC and a much more extensive stretch of steel sheeting and asphalt pavement along the Lake Michigan shoreline through Veterans Park. The "flushing tunnel" concrete wall at the north edge of the park appears to be in very poor condition and is reported to be undermined.



Promenade at the MAM/WMC



Sheet pile and asphalt trail



North Parking Lot at water's edge



Sewer structure and mooring dolphin



Multi-use trail at peninsula



Flushing Tunnel inlet wall at north end



## 2.4 Stormwater

The project area is flanked along the western boundary by the original Lake Michigan bluffs which includes Juneau park and high rise development along Prospect Avenue. Over time, the lake-front area has been filled to create parkland. Relatively flat, drainage from the upper bluff and Lincoln Memorial Drive flows overland and via a network of storm sewers discharging untreated to the Veterans Park lagoon or directly into Lake Michigan. Treatment of roadway and parking lot run-off presents outstanding opportunities for improving habitat and the water quality of the lagoon and lake.



Storm Sewer Outfall along LMD



Parking lot inlet



Poor Water Quality at Lagoon



Square corner collects debris

## 2.5 Historical Geotechnical Evaluation

As part of the study, two historical geotechnical exploration and analysis reports were reviewed; 1) "Proposed Milwaukee Art Museum Addition" by Giles Engineering Associates, October 18, 2013 and 2) "Proposed Veteran's Park Shelter Building" by PSI, July 9, 2012. Giles evaluation consisted of three soil borings within the footprint of the new addition. Soils encountered consist of undocumented fill from the surface to a depth of 17 to 19 feet. The fill was composed of gravel, sand, silt, ashes and cinders fragments. The water table was encountered at a depth of 10 to 12 feet, about the level of Lake Michigan at the time of testing. The PSI evaluation was performed in the concession area of Veterans Park for a new pavilion. This exploration encountered undocumented fill material from the surface to a depth of 16 to 20 feet. Groundwater was observed at depths of approximately 10 to 19 feet and likely corresponds with Lake Michigan levels. The presence of undocumented fill must be considered as an environmental concern for any land disturbing activities especially for parking lot, green infrastructure configuration and underground utility construction.

## 2.6 Infrastructure

The site has various utilities that serve Milwaukee County Veterans Park owned concession building and facilities to support an assortment of function and park use. Power, cable and water enter the site along the east wall of the Mason Street ramp. A major power loop serves the large open field for large events (concerts, circus, private parties, etc.) concession buildings, bathrooms and pavilions. Water services are also distributed throughout the park. Lincoln Memorial Drive serves as the primary vehicular artery with the Mason Street Bridge ramp providing downtown access/exit. See *Figure 1: Existing Site Utilities*.

Sanitary sewer serves the bathrooms and food concession areas. A storm sewer system collects and conveys stormwater from the bluff, Lincoln Memorial Drive and the various parking lots discharging untreated into the lagoon or Lake Michigan. See *Figure 2: Topography and Storm Sewer System*



Electrical power transformer



Water service



Incomplete and Deteriorating Curb



Water Outlet

## **2.7 Programmatic Objectives**

The Steering Committee and planning consultant established the programmatic objectives to be considered for the planning effort as a holistic approach to interface the shore land with Lake Michigan with the following benefits; Ecological, Economic and Cultural, the Public Realm and Urban Design

### **Ecological**

- Water Quality- address stormwater runoff from pavements discharging to Veterans Park lagoon and Lake Michigan with green infrastructure approaches
- Water Conservation- consider reduction of direct discharge
- Habitat Enhancement- provide naturalized landscape to improve habitat
- Bird and Insect Flyway- enhance the flyway for the urbanized section of Lake Michigan shoreline
- Design Features- apply green infrastructure techniques that fit within the parkland and institutional campus setting
- Ecological Sustainability- consider practical, low maintenance approaches that reduce environmental impacts, long term savings, operational efficiencies and management benefits
- Stewardship of Lake Michigan- with Milwaukee's fresh water-centric initiatives and long standing environmental ethic, encourage actions that care for the Lake, our most valuable regional natural resource.

### **Economic**

- Local and Tourist Destination Appeal- improvements to enhance the experiences for this popular, highly used area.
- Catalyst for Downtown Investment- as the front door to Downtown, a thoughtful plan for vehicle, bike and pedestrian connections with other neighboring venues including parkland to the north, the future Gateway and entertainment venues to the south.
- Support of the Institutional Campus- emphasize access, parking, site programming that support the War Memorial Center, Milwaukee Art Museum, Discovery World and Betty Brinn Children's Museum.
- Eco-tourism- establish as setting for birding, native restoration, innovative stormwater management examples, research, environmental education field study and related activities.

### **Cultural, the Public Realm and Urban Design**

- Place Making- evolve public spaces into community places
- Public Access and Connectivity to the Lakefront- improve the assorted ways visitor access the area interfacing with the land the established infrastructure. Establish handicap accessibility especially near the Southeast Wisconsin Vietnam Veterans Memorial.
- Open Space Design- enhance the "green space" for parkland including the open grassy field, shoreline
- Community Wellness- encourage active life styles for outdoor recreation and fitness on land and in the water
- Innovative/Responsible Site Design and Engineering
  - Alternatives to more traditional pavement and pipe approaches for stormwater management
  - New Materials- consideration of porous pavements, soil amendments, repurposed materials
  - Native Plantings- for habitat, canopy, stormwater treatment, erosion control
  - Long Term Cost/Operational/Management Benefits- consider the demands for cost conscious solutions that aim to reduce long term operation and maintenance efforts
- Educational/Interpretive Communications
  - Ecological information
  - Heritage/Cultural opportunities for public art, memorials, monuments, healing gardens, veteran recognition

The Existing Conditions figure presented in this section highlights some of the programmatic objectives.





# Existing Conditions



## War Memorial and Veterans Park Future Projects Along Milwaukee's Shoreline





### **3. STAKEHOLDER AND PUBLIC INPUT**

The project area, including Veterans Park, segments of the Oak Leaf multi-use trail, Lake Michigan shoreline, the Vietnam War Memorial, and the lagoon, serves as a destination for Milwaukee region residents and visitors. In addition, the project area includes parking lots serving the War Memorial Center, and Milwaukee Art Museum. Given the proximity to several businesses and organizations, and the project area's status and popularity, stakeholder input was essential in the planning process.

The planning consultant, along with the Steering Committee, made a significant effort to ensure that the stakeholder and public input was actively sought out and used as a key element in informing the team on what improvements were needed and desired by those who use the project area. The process that the planning consultant employed to ensure both the availability of information and a pathway for feedback back to the team is described below.

#### **3.1 User/Interested Group Identification**

The names and affiliations included in the stakeholder list were primarily identified by the Steering Committee and Fund for Lake Michigan. When considering the stakeholder list, as many user groups as possible that had either direct ties to the project area or had a possible interest in the planning for future improvements were included. This list included representatives from a wide-ranging group of Milwaukee organizations and businesses. The stakeholder list included War Memorial Center Tenants, Milwaukee County Parks staff, representatives from the City of Milwaukee Departments of City Development and Public Works involved with the Gateway Project and downtown development, neighboring institutions such as Discovery Work, Lakeshore State Park, Summerfest, various park user groups and Veterans. The stakeholder list was comprised of approximately 50 organizations and businesses as presented in *Appendix A*.

In the beginning of the planning process, representatives of these groups were invited to attend a stakeholder meeting. Stakeholder involvement included two stakeholder meetings, a planning workshop, and additional focus group sessions.

#### **3.2 Stakeholder Meeting #1**

On July 14, 2016, Stakeholder Meeting #1 was held at the War Memorial Center. See *Appendix A* for the listing of project stakeholders. Stakeholder Meeting #1 focused primarily on the North Parking Lot and green infrastructure associated with potential reconfiguration.

Following the stakeholder meeting all information collected was circulated amongst members of the planning consulting team for verification to ensure that these notes accurately recorded the information shared by stakeholders.

#### **3.3 Design Workshop**

On September 14, 2016, a Planning Workshop was held at the WMC involving the planning consultant, representatives from the County and City, UWM's James Wasley, and select stakeholders. This session focused on three primary aspects, the output of which were diagrammed. See *Appendix B* for diagrams regarding each aspect.

- 1) GREEN INFRASTRUCTURE/WATER QUALITY
  - Stormwater and runoff
    - Capture and treat before entering lagoon and Lake Michigan
    - Remove sediment
  - Replace portions of large areas of turf grass with meadow grass
  - Lagoon
    - Provide surface water connections to harbor on both ends
    - Improve water movement and quality
    - Rethink capturing water from upland + Lincoln Memorial

- Shoreline modifications
  - Fill, create terraced steps to water's edge, "Touch the Water"
  - Increase landscaping
  - Soften shoreline and increase natural buffers
  - Enhance habitat
  - Reduce pooling garbage
  - Enhance public experience
- Parking
  - Move away from water's edge
  - Buffer Parking from bike and pedestrian areas
  - Energy generation opportunities (solar) integrated with parking
  - Tree canopy in parking lots and more trees introduced to park in general
  - Capture and treat water from parking lot locations
  - Implement options which reduce maintenance
  - Replace asphalt with green pavers, make eco parking lot with bioswales
  - Explore O'Donnell Park parking deck use

## 2) CIRCULATION/CONNECTIONS

- Protect Basin
  - Reduced wave climate, water calming, breakwater islands
  - Enhance habitat
  - Recreational opportunities
  - Sailing basin, kayaks, paddle boats
  - Mooring basin
- Bike and pedestrian access
  - New multi-use trail connection along northbound Lincoln Memorial
  - Improve pedestrian crossing from Ogden
  - Bumpouts/remove parking lane
  - Separate uses (bike trail, pedestrian promenade, gravel walks)
  - Explore Pedestrian bridge from Juneau Park
  - Extend bike path connection from existing pedestrian bridge towards marina basin
- Vehicular access
  - Realign E. Lagoon Dr. to open up more of the park
  - Widening of E. Lagoon Dr. and add angled parking
  - Combine/Consolidate parking lots on the north of the Site
  - Relocate existing entrance to the north to reduce conflict
  - Relocate access point farther north and create a loop with E. Lagoon Dr.
  - Create an arrival experience from the North to the War Memorial
  - North turning lane added exiting the War Memorial
  - Managed shuttle for large events
  - Narrow travel lanes on Mason Street ramp
- Structured parking options
  - Redesigned public and private parking
  - Multi-level under Mason Street ramp
  - Multi-level structure locate to the north of War memorial (Enhanced entry with Green roof)
  - Accessible parking for memorials (especially Vietnam War Memorial)
- Other
  - Maintain service docks for Milwaukee Art Museum, War Memorial and commercial needs
  - Create viewshed from Juneau Park down to the five points in the park
  - Wayfinding system

### 3) PROGRAMMING

- Water Activities (lagoon, bay, lake)
  - Water taxi opportunities/docking
  - Maintain sailing opportunities (Milwaukee sailing center/Lessons)
  - Maintain Boat rental opportunities
  - Pond hockey
  - Canoe/Kayak launch with small parking/drop-off area
  - Enhance wave protection(water calming)
    - New breakwater
    - Breakwater islands
    - Create protected shoreline areas
    - Provide view opportunities from islands
    - Picnic areas with sand areas to pull up kayak/canoe
    - Mooring area
    - Art installations
- Sport courts
  - Cricket
  - Bocce Ball
  - Pickleball
- Kids Activities
  - Playground
  - Splashpad
  - Skate park
  - Climbing wall
  - Ropes and bridges course
  - Zip line
- Existing open area
  - Maintain/enhance kite flying area
- Shoreline
  - Lookout tower/observation deck
  - Iconic destination on point
  - Farmers market
  - Boardwalk
  - Vendors/Kiosks
  - Food truck
- War Memorial and Monument
  - Enhanced Memorial experience
  - Vietnam War Monument seating/contemplation area
  - Interpretive signed route with history and military branch dedications
- Other
  - Big events
  - Outreach and educational opportunities
  - Wedding event location
  - Stage acts and movies
  - Performance pavilion
  - Dog sled racing
  - Improve existing retail clusters

### **3.4 Stakeholder Meeting #2**

On September 29, 2016, Stakeholder Meeting #2 was held at the War Memorial Center. See *Appendix A* for the listing of project stakeholders. Three interchangeable concept alternatives were created for discussion at the stakeholder sessions. The sessions were organized by similar interests

- War Memorial Center Tenants
- Gateway and Downtown
- Park Users

Discussion followed with a variety of comments and suggestions from the attendees which were used by the planning consultant to further refine the Vision Plan. Following the second stakeholder meeting all information collected was circulated amongst members of the planning consulting team for verification to ensure that these notes accurately recorded the information shared by stakeholders. See *Appendix C for Stakeholder Meeting #2 Notes*.

### **3.5 Focus Group Meetings**

Focus group meetings were conducted with the following organizations:

- City of Milwaukee Departments of City Development & Public Works - Karen Dettmer (DPW), Kristin Bennett (DPW-bike and pedestrian), Greg Patin (DCD)
- Port of Milwaukee - Larry Sullivan
- Milwaukee County Executive/Economic Development and Dept. of Administration representatives
- Milwaukee Art Museum - Marcelle Polednik, Executive Director
- Milwaukee County Parks, Energy and Environment Committee-Jason Haas, Chairperson.
- Fund for Lake Michigan - Vicki Elkin /MMSD Lisa Sasso

### **3.6 Public Meeting**

On March 14, 2017, a public meeting was held at the War Memorial Center. See *Appendix A* for attendance. Prior to the meeting, the planning consultant sent out an invite via e-mail that was distributed to the stakeholder list but also the latest version of the Vision Plan was presented along with a description of the design analysis and stakeholder involvement process. The agenda for that presentation included:

- 1) Opening welcome and comments by County staff
- 2) Introduction of the planning consulting team
- 3) Brief summary of the prior planning process steps
- 4) Summary of Programmatic Objectives
- 5) Review of existing conditions
- 6) Green Infrastructure strategies
- 7) The proposed Vision Plan
- 8) Parking lot options and details
- 9) Comments from the public



Milwaukee County Parks Director John Dargle

Approximately 20 individuals attended in addition to County staff and the planning consulting team. During the open house and prior to the formal presentation, county staff and the planning consulting team were available for one-on-one conversations and explanations of the proposed plan. The Vision Plan, parking lot options, and renderings were laid out for discussion before and after the public meeting presentation. Attendees were encouraged to provide feedback and place post-it comments on the proposed plans. Public input comments are summarized below.



Pedestrian Connections – *Disabled Access/ Vietnam War Memorial Parking Lot*

- Too many parking spots in front of the memorial
- No new parking should be created, loss of greenspace not appreciated
- Put handicap parking along the entrance road with bump outs to eliminate Vietnam War Memorial parking lot.
- Offer free parking to vets

Pedestrian Connections – *Parking Lot D*

- Screen or sink lot so cars are hidden

Vision Plan – *Bay Enhancement Project*

- Islands in waterway may impact boating
- Love connection from lagoon to Lake Michigan

Vision Plan – *Lincoln Memorial Drive*

- Connect top of bluff to Lincoln Memorial Drive or WMC with steps or bridge
- Reducing lane may create bottleneck
- Need “wrong way” signage

Vision Plan – *Stormwater Solutions*

- Add permeable pavement to widen promenade
- Native vegetation to be people-friendly

## 4. STORMWATER BMP EVALUATION

### 4.1 Site-wide Stormwater Management/Green Infrastructure

A key aspect of the project planning process was to identify ways to treat stormwater at the project site and identify best management practices (BMP's) to improve lakeshore health. Green Infrastructure (GI) was considered as a primary way to treat and manage stormwater along the shoreline. GI meets stormwater management goals by providing storage, volume reduction, and treatment. Additionally, GI such as bioretention or stormwater trees includes native vegetation to optimize infiltration and evapotranspiration, and enhances shoreline habitat, especially for migrating birds and insects. Native plantings within GI can be strategically spaced to navigate visitors in and through particular spaces (i.e. contemplative gardens, along pathways, trees for shade). Native vegetation, once established, generally requires less maintenance costs and attention than typical turf grasses and landscaping. Annual mowing and weeding manage plant species and size, where typical turf grass requires very regular mowing during the growing season. Some GI is also intended to be used as a multi-functional space. For example, porous pavement can be placed in parking stalls or along pathways to provide stormwater management as well as typical pavement uses. All GI provides a variety of educational opportunities, including topics such as shoreline habitat, stormwater and water the water cycle, native plants, and migrating birds. Ultimately, the incorporation of GI through the Milwaukee shoreline will meet stormwater objectives for protecting Lake Michigan while also including many of the other stakeholder visions of how our public spaces should be used.

Present below are the GI approaches applicable to the setting for stormwater management.



#### Bioswales

*Landscape features that capture and infiltrate runoff and can also remove pollutants.*



#### Greenways

*Riparian and non-riparian buffer zones and strips that store and drain stormwater runoff into the ground naturally.*



#### Native Landscaping

*The use of native plants that can tolerate drought and flooding cycles because of deep roots and climate-specific adaptations.*



#### Porous Pavement

*Pavement that can reduce and infiltrate surface runoff through its permeable surface into a stone or filter media below.*



#### Rain Garden

*Gardens that are waters by collected or pooled stormwater runoff, slowly infiltrating it into the ground along root pathways.*



#### Soil Amendments

*Materials worked into the soil to enhance its ability to infiltrate or absorb water.*



#### Trees

*Trees that can hold rainwater on their leaves and branches, infiltrate it into the ground, absorb it through root systems, and evapotranspire it into the atmosphere.*

The Long Term Vision Water Quality Enhancements figure shown below depicts the paved areas, stormwater outfalls and areas where green infrastructure approaches make sense. Note the Veterans Park lagoon receives significant urban runoff from Lincoln Memorial Drive and the upland developed area west of the project limits.



-  Stormwater Collection and Treatment Opportunities
-  Parking Lot
-  Parking Lot Stormwater Opportunities
  - BMP
  - Parking Layout
  - Structured Parking
-  Shoreline Treatment Opportunities
-  Outfall Enhancements

### Long Term Vision Water Quality Enhancement Opportunities



## 4.2 North Parking Lot Improvements (Phase I)

Evaluation of the proper stormwater BMP technologies to use on site is imperative for efficient and functional stormwater treatment. Using the expertise of the planning consultant, along with the geotechnical report and site characteristics, the planning consultant evaluated the BMP practices that would be most successful for the site. The following technologies were incorporated into the final conceptual design:

- *Native Landscaping*- The use of native plants that can tolerate drought and flooding cycles because of deep roots and climate-specific adaptations. It provides habitat for migrating birds and insects, and enhances shoreline habitat.
- *Porous Pavement*- Pavement that reduce and infiltrate surface runoff through its permeable surface into a stone or filter media below but allows for typical surface uses (i.e. parking, walking)
- *Bioswales*- Landscape features that capture and infiltrate runoff to remove pollutants and incorporates native plantings, pathways to help direct/navigate visitors

The proposed Phase 1 improvements include reconstructing Parking Lots A and B and incorporating green infrastructure to manage runoff. Parking Lot A will primarily be constructed using traditional asphalt, but will also have 10,650 sf of porous paver parking stalls to capture, store, and treat runoff. Parking Lot B will incorporate 1,360 sf of bioretention along its eastern edge to store and treat stormwater runoff. The existing Parking Lot C will be demolished, and replaced by native plantings. Parking Lot D, which will replace the parking capacity of lot C, is proposed to be located upslope closer to Mason Street. Runoff from Parking Lot D will drain to a 4,800sf terraced bioretention. Parking Lot E will also incorporate 1,440 sf bioretention along its eastern edge to capture and treat stormwater runoff. A partially porous multiuse path is proposed along Lincoln Memorial Drive will be installed to improve pedestrian connectedness along the shoreline with minimal increase in impervious surface. Ultimately, the proposed green infrastructure is estimated to provide 152,598 gallons of storage per storm and reduced sediment loading by at least 1,216 lbs annually (more in-depth modeling will occur in the design phase). See Figure 3- Greenprint for Milwaukee Shoreline Phase 1 which present conceptual GI design elements for the North Parking Lot.

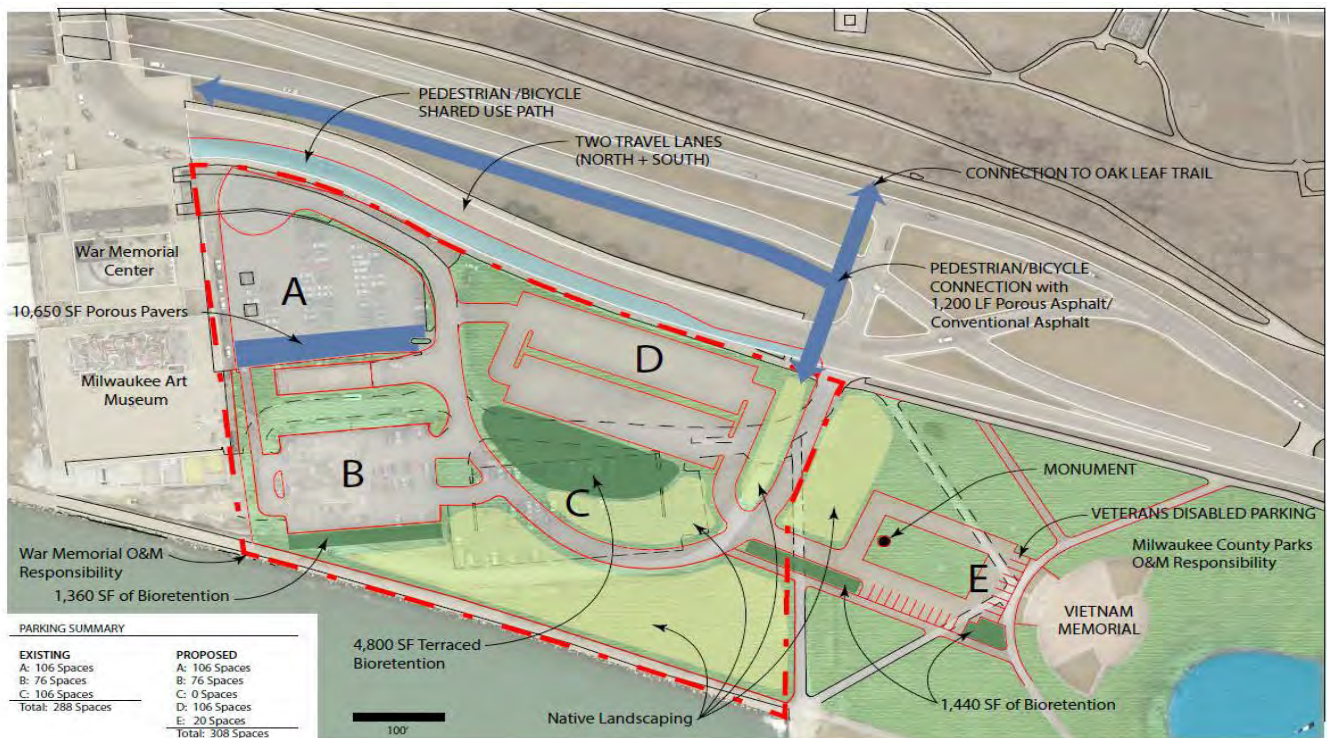

## **5. VISION PLAN**

Milwaukee's Lakefront is one of the most active destinations in the County and provides a tremendous opportunity for area residents and visitors to enjoy leisure activities, family recreational opportunities, seasonal celebrations, larger event gatherings and visiting the many institutional landmarks along Lake Michigan. The **Greenprint-Milwaukee Shoreline Vision Plan** creates opportunities to maximize and enhance all functions of Milwaukee's near downtown lakefront. Establishing visual and physical connectivity to the site area allows access to the Oak Leaf Trail, general park use and a major thoroughfare between all the civic destinations found along Milwaukee's lakefront. The landscapes along Lincoln Memorial Drive, within the open parkland and along the shoreline all define the experience. The relationship to the Lake has remained the highest priority for the County, City, Community and all the lakefront users. The ability to touch the water is a powerful objective, whether physically, physiologically or metaphorically. This underscores the focus on water quality enhancement throughout the Vision Plan.

On a broader scale, Milwaukee County and City properties provide a well-connected trail system with access to the Oak Leaf Trail, general park use and a major thoroughfare between all of the civic destinations found along Milwaukee's lakefront and a major vehicle connection to Downtown. To access this area there are strategic vehicular roads and parking facilities which provide the necessary infrastructure to access the lakefront. The landscapes along Lincoln Memorial, within the open parkland and along the shoreline all define the experience. The ability to move people from north to south, honor dedicated recreational uses, maximize flexibility in programming between the many established venues and the ability to connect visually and physically to the Lake attract people on a national level is primary. This planning effort strives to integrate into the larger vision for the Lakefront including the Gateway, Summerfest, Lincoln Memorial Drive/Hone Bridge reconfiguration.

One of the primary goals of the Vision Plan is to build on the well-respected traditions that Milwaukee County Parks and Milwaukee's historic leadership have provided over generations. By incorporating design and planning standards focused on green operational standards the Vision Plan promotes a more sustainable public amenity. Throughout the planning process special consideration was given to innovative parking lot design, water quality focused stormwater management strategies and improved pedestrian movement between the various park user zones. In order for sustainable design elements to have their greatest effect they need to be integrated into the planning process and the park programming. This approach proactively integrates sustainable stormwater measures into the design elements of the parking lot, access paths that may include bio-infiltration areas and porous pavements.

The relationship to the Lake has remained the highest priority for the County, City, Community and all of the Lakefront users. The ability to touch the water is a powerful objective, whether physically, physiologically or metaphorically. This underscores the need to focus on water quality as a major issue and keep it in the forefront through the process. Lake Michigan is the greatest natural resource and biggest attraction for the park and its ability to successfully serve the community, while attracting tourism and positive economic benefits. The simultaneous creation of habitat as water is managed ecologically adds aesthetic value that will enhance the public's perception and image of Milwaukee as a foreword looking water-centric city.

### **5.1 Vision Plan Aspects**

The Vision Plan presented in this section meets the programmatic objectives presented in Section 2 as the basis of design by achieving the key goals of the project which is improve programing, ecology and environmental health, and park access. The Vision Plans provides specific recommendations for incorporating green infrastructure, creating consistent circulation of flow for connections for vehicles, pedestrians, bikers, and other park users with landscaping, pathways, and parkland features. The Vision Plan shows potential site improvements and facility improvements.



# Greenprint-Milwaukee Shoreline Vision Plan

1. ENHANCED STORM MANAGEMENT AREA
  - INTRODUCE "GREEN INFRASTRUCTURE" ADJACENT TO LAKE
  - MOVE EXISTING PARKING LOCATION TOWARDS MASON STREET RAMP
  - ADJUST VEHICULAR ENTRANCE FROM LINCOLN MEMORIAL
2. LAGOON + WETLAND + CONNECTION TO LAKE
  - STORMWATER MANAGEMENT ENHANCEMENT
  - RE-ALIGN LAGOONS
  - ADDITIONAL BOARDWALKS
  - CREATE WETLAND CELLS AS BUFFERS ALONG LINCOLN MEMORIAL
3. MEADOW - FLEX PROGRAMMING
  - RENOVATION
  - RETAIL VILLAGE UPGRADE
4. NORTH / EAST AMENITY ZONE
  - RESTROOM RENOVATION
  - PLAYGROUND
5. NORTH/ WEST AMENITY ZONE
  - PAVILION PLAZA
  - RESTROOM RENOVATION
  - SHORELINE RECONSTRUCTION
6. EXISTING PARKING LOT
  - STORM WATER GREEN INFRASTRUCTURE
7. SHORELINE PROMENADE
  - FILTRATION PLANTERS
  - SEPARATE PEDESTRIAN + RECREATIONAL TRAILS
8. BAY ENHANCEMENT PROJECT
  - ENHANCE GEOMETRY AT CORNERS
  - INTRODUCE FEATURES TO "TOUCH THE WATER"
  - CONNECT TO LAGOON
  - (>1' WAVES) WITH BREAKWATER ISLANDS

NOTE: ALL PHASES WOULD INCLUDE TRAIL UPGRADES





The following are the eight primary aspects presented in the Vision Plan:

### 1. Enhanced Storm Management Area



- *Introduce green infrastructure adjacent to the lake*
- *Move existing parking lot location towards Mason Street ramp*
- *Adjust vehicular entrance from Lincoln Memorial Drive*

The impervious roadways, paths, parking lots, and structures offer opportunities to incorporate GI element such as porous pavement, bioswales, native landscaping especially for the largest area of the north lot. See Section 6 that further discussion North Parking Lot conceptual plan.

### 2. Lagoon + Wetland + Connection to Lake Michigan



- *Stormwater management enhancement*
- *Re-align lagoons*
- *Additional boardwalks*
- *Create wetland cells as buffers along Lincoln Memorial Drive*

The high pedestrian/ bike traffic can be augmented with boardwalks and semi-porous construction materials providing an enhanced experience. With the lagoon receiving much of the runoff from the Lincoln Memorial Drive and upland areas, the storm system outfalls can be reconfigured to pretreat water. Consideration of connecting Lake Michigan with the lagoon will require evaluation and input by regulatory agencies.

### 3. Meadow – Flex Programing



- *Renovation*
- *Retail village upgrade*

A more deliberate organization and architectural treatment of concession areas would improve economics of private vendor rental. The highlyutilized meadow to be maintained and improved with soil amendments and hearty grasses.

### 4. North / East Amenity Zone



- *Restroom renovation*
- *Playground*

Provide enhancements such as playground to activate this area as destination. Improve the screening surrounding the Community Sailing Center more pleasing materials.

### 5. North / West Amenity Zone



- *Pavilion Plaza*
- *Restroom renovation*
- *Shoreline Reconstruction*

The Old Coast Guard pavilion and surrounding area offers unique open space for public and private events, gatherings, field sports and opportunities to experience the marina. The poor condition of the flushing tunnel wall will require reconstruction that could include reconfiguring the inlet to better small boat launching. The Brady Street multi-use bridge ramp to be reconfigured to create better access to the area.

## 6. Existing Parking Lot



- *Stormwater green infrastructure*

Marina and parkland roadways, trails and parking lots should incorporate various GI strategies when conditions warrant replace. Consideration for naturalize buffers and bioswales.

## 7. Shoreline Promenade



- *Filtration planters*
- *Separate pedestrian + recreational trails*

The extensive sheet pile wall can be enhanced simple planters, benches, photocell lighting, GI, pocket park features, trees, and native plantings. The concept of “touch the water” should be incorporated into select future reconstruction of the current sheet pile dockwall.

## 8. Bay Enhancement Project



- *Enhance geometry at corners*
- *Introduce features to “touch the water”*
- *Connect to lagoon*
- *(>1’ waves) with breakwater islands*

Touch the water elements can be incorporated in new construction especially in the pocket corners where there is poor water circulation. Encourage small non-motorized paddle craft in the near shore with breakwater islands and the potential navigable connection with the lagoon.

### 5.2 Funding Opportunities

Throughout the project the Steering Committee and planning consultant and looked to engage public and private entities that may be interested in providing funding to support the project. There was significant amount of interest from The National Fish and Wildlife Foundation-Sustain Our Great Lakes, The Fund for Lake Michigan, MMSD to become involved in the project and fund specific parts of the project that supported their group’s goals and interests. Coinciding with the planning effort, grant applications for the North Parking Lot improvements referred to as Phase I were prepared and submitted to these entities on behalf of the War Memorial Center by Stormwater Solutions Engineering, Inc. Each of the grant applications showed Milwaukee County’s participation in funding of approximately \$600,000 for the parking lot improvements. *Grant applications are found in the Compendium of the report.*

In addition to these specific grants for initial North Parking Lot improvements (Phase 1), there are opportunities within the Vision Plan for additional financial support in future improvement projects. *A partial listing of grants and related funding programs is presented in the Compendium of the report.*

## 6. NORTH PARKING LOT CONCEPTUAL PLAN

The Phase 1 focuses on the outdoor space north of the War Memorial Center Milwaukee Art Museum including renovation the deteriorating parking lots while incorporating multi-use porous pathways, bioretention, porous pavement, and native plantings to manage stormwater runoff and associated pollutant. Plantings will be a layered design of diverse native plantings that will provide food and shelter of migratory birds and other shoreline wildlife. Additionally, education and public artistic elements will be considered to provide visitors a sustainable shoreline education and experience while acknowledging the need to honor military veterans.

### 6.1 Parking Lot Configuration Alternatives

Although the site does have some flexibility with temporary parking on undeveloped areas with an overall existing parking count of 288 spaces on paved parking lots. The outcome of the planning process considered in the development of various concepts for reconfiguring the parking, access and bike/pedestrian connections. Four alternative concept plans were created for Phase 1; "A", "A.2", "B", and "C". *Figures 5-12 present conceptual layouts and renderings of the North Parking Lot alternatives.*

**Concept A:** Maintains existing vehicular entrance at the intersection of Lincoln Memorial Drive and the Mason Street ramp at current location. Lot D to be located on the terrace tucked next to the Mason Street ramp replacing Lot C. The relocation of Lot D provides a greater setback from the water's edge and provides an area for green infrastructure to manage stormwater. The entrance drive is a more inviting view of the lake and gently curves toward the WMC and MAM entrances along the north side of the building. A small parking area with handicap parking is provided adjacent to the Vietnam Veterans Memorial. The two lanes of vehicle traffic north and south bound on the Mason Street ramp would be reduced to one lane in each direction to allow for a widening of multi-use on the ramp. The undeveloped "goat path" along the north bound LMD would be established as paved trail. See *Figure 5: Phase 1 – Concept A* and *Figure 6: Phase 1 – Concept A – Pedestrian Connections*

**Concept A.2:** Parking Option A with an alternative parking and pedestrian plaza adjacent to the Vietnam Veterans Memorial. See *Figure 7: Phase 1 – Concept A.2 – Pedestrian Connections*

**Concept B:** Move vehicular entrance north and reconfigure Lincoln Memorial Drive intersection. This allows for sequencing construction of Concept A or A.2 initially. See *Figure 8: Phase 1 – Concept B*

**Concept C:** Parking concept B + Lagoon enhancements by adding a water feature surrounding the Vietnam Veterans Memorial. See *Figure 9: Phase 1 – Concept C*

### 6.2 Operation and Maintenance

The proposed project includes infrastructure that requires both short term operation and maintenance requirements for the County. The planning consultant has proposed elements that minimize extra ordinary maintenance. However, there are specific items that will require maintenance for them to function properly; specifically the stormwater BMPs. Maintenance costs from established Milwaukee County GI sites were used to estimate annual maintenance costs for this project. Based on the data, the War Memorial Center and Milwaukee County Parks will need to commit allocated funds within their annual budgets accordingly, to ensure GI storage, water quality, and habitat benefits will be sustained over time.



### 6.3 Cost Projection

Cost projection for the initial North Parking Lot improvements (Phase 1) designate within the red border on the figure below were developed by Stormwater Engineering Solutions, Inc. as part of the various grant applications. The original cost estimate with a breakdown of requested grant contributions is present within the grant applications found in the compendium of the report.

|  | Unit | Cost        | Amount            | Total                 |
|--|------|-------------|-------------------|-----------------------|
| <b>CONSTRUCTION</b>  |      |             |                   |                       |
| Mobilization   | LS   | \$20,000.00 | 1                 | \$20,000.00           |
| Demo/Landfill Existing Lots                                  | SY   | \$3.00      | 16,000            | \$48,000.00           |
| New base course (no fines)                                   | TON  | \$20.00     | 279               | \$5,580.00            |
| Storm sewers & manholes                                      | LF   | \$100.00    | 350               | \$35,000.00           |
| Asphalt pavement   | TON  | \$80.00     | 3,348             | \$267,840.00          |
| Porous Pavers in Lot A                                       | SF   | \$12.00     | 10,650            | \$127,800.00          |
| Concrete curb  | LF   | \$12.00     | 500               | \$6,000.00            |
| Turf restoration   | SY   | \$3.00      | 4,000             | \$12,000.00           |
| Painting/stripping/signage                                   | LS   | \$18,000.00 | 1                 | \$18,000.00           |
| Painting/re-stripping at Mason St. Bridge                    | LS   | \$20,000.00 | 1                 | \$20,000.00           |
| Asphalt pedestrian path on Lincoln Memorial Dr.              | LF   | \$37.50     | 1,200             | \$45,000.00           |
| Porous paver edge to pedestrian path on Lincoln Memorial Dr. | LF   | \$40.00     | 1,200             | \$48,000.00           |
| Light poles & electrical                                     | EA   | \$10,000.00 | 6                 | \$60,000.00           |
| Excavation/grading for relocated lot                         | CY   | \$20.00     | 1,800             | \$36,000.00           |
| Porous walkway and pavers                                    | SF   | \$8.00      | 4,800             | \$38,400.00           |
| Bioretention w/ lining and plantings                         | SF   | \$35.00     | 7,600             | \$266,000.00          |
| Native Landscaping   | SY   | \$5.00      | 9,680             | \$48,400.00           |
| 3-Year Plant Warranty  | EA   | \$36,300.00 | 1                 | \$36,300.00           |
|  |      |             | <b>Sub-Total:</b> | <b>\$1,138,320.00</b> |
| <b>PUBLIC EDUCATION</b>                                      |      |             |                   |                       |
| Public art and signage                                       | TOT  |             |                   | \$85,000.00           |
| Public Service Announcements                                 | TOT  |             |                   | \$5,000.00            |
| Staff Training   | HR   | \$150.00    | 2                 | \$300.00              |
| Monitoring   | TOT  |             |                   | \$15,000.00           |
|  |      |             | <b>Sub-Total:</b> | <b>\$105,300.00</b>   |
| <b>GENERAL REQUIREMENTS</b>                                  |      |             |                   |                       |
| General Conditions   | %    | 10          |                   | \$113,832.00          |
| Contingency  | %    | 10          |                   | \$113,832.00          |
| Design & management  | %    | 10          |                   | \$113,832.00          |
|  |      |             | <b>Sub-Total:</b> | <b>\$341,496.00</b>   |
|  |      |             | <b>Total:</b>     | <b>\$1,585,116.00</b> |

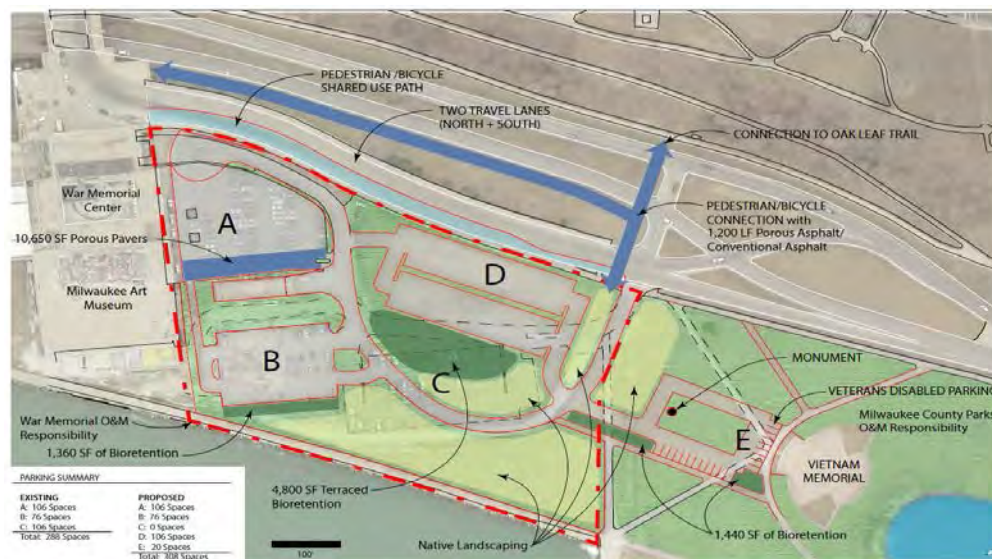



**Figure 1**  
Existing Site Utilities



File: I:\War Memorial\16270-Master Plan\060 CAD/C - CIVIL\0605 VETERANS PARK UTILITIES\16270-VETERANS PARK UTILITIES.dwg



CALL DIGGERS HOTLINE  
1-800-242-8511  
TOLL FREE  
MS STATUTE 182.07(7)(9)A  
REQUIRES MIN. 2 WORK DAYS  
NOTICE BEFORE YOU DIG.  
MILW. AREA 259-1181

THE UNDERGROUND UTILITY INFORMATION SHOWN ON THIS MAP IS BASED ON FIELD MARKINGS AND INFORMATION FURNISHED BY UTILITY COMPANIES AND THE LOCAL MUNICIPALITY. WHILE THIS INFORMATION IS BELIEVED TO BE RELIABLE, ITS ACCURACY AND COMPLETENESS CANNOT BE GUARANTEED.

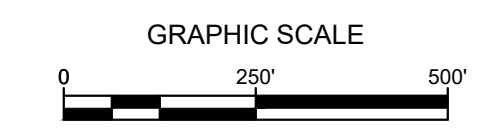

**LEGEND:**

- W --- PROPOSED WATER SERVICE
- SAN --- PROPOSED SANITARY SERVICE
- ST --- PROPOSED STORM SEWER
- E --- PROPOSED ELECTRICAL SERVICE
- T --- PROPOSED TELEPHONE SERVICE
- G --- PROPOSED GAS SERVICE
- PROPOSED STORM INLET
- PROPOSED STORM MANHOLE
- PROPOSED SANITARY MANHOLE

**GENERAL NOTES:**

1. THE UNDERGROUND UTILITY INFORMATION SHOWN ON THIS DRAWING IS BASED ON FIELD LOCATIONS AND/OR RECORDS FURNISHED BY MUNICIPALITIES AND UTILITY COMPANIES. THE LOCATION AND ACCURACY OF WHICH CANNOT BE GUARANTEED. THERE MAY BE ADDITIONAL UNDERGROUND UTILITY INSTALLATIONS WITHIN THE PROJECT AREA THAT ARE NOT SHOWN.
2. VERIFY ACTUAL LOCATIONS AND INVERTS IN THE FIELD. ANY POTENTIAL ERRORS, OMISSIONS, OR DISCREPANCIES SHALL BE BROUGHT TO THE ATTENTION OF THE ENGINEER PRIOR TO PROCEEDING WITH CONSTRUCTION.
3. WORK TO BE COMPLETED IS INDICATED IN BOLD TYPE LINES AND EXISTING CONDITIONS ARE INDICATED BY LIGHT TYPE LINES.
4. ELECTRONIC CIVIL FILES ARE AVAILABLE UPON WRITTEN REQUEST. DO NOT USE ELECTRONIC CIVIL FILES TO LAYOUT FOUNDATIONS, COLUMN LINES, LIGHT POLES, OR OTHER NON CIVIL SITE WORK. REFER TO ARCHITECTURAL DRAWINGS FOR DIMENSIONS OF BUILDING AND ARCHITECTURAL FEATURES.
5. ALL UTILITIES WITHIN 5 FEET OF PAVED AREAS SHALL REQUIRE GRANULAR BACKFILL. SLURRY BACKFILL IS REQUIRED FOR ALL WORK IN PUBLIC RIGHT OF WAY.
6. PRIVATE STORM INLETS IN PAVEMENT SHALL REQUIRE DRAIN TILE STUBS OF 10 FEET IN TWO DIRECTIONS FOR SUBDRAINAGE. RIM GRADE FOR STORM INLETS IN CURB AND GUTTER ARE FLOW LINE GRADES.
7. WORK IN PUBLIC RIGHT OF WAY SHALL FOLLOW MATERIAL AND INSTALLATION REQUIREMENTS PER MUNICIPAL AND/OR COUNTY.
8. PRIVATE STORM SEWER 12-INCH DIAMETER OR LARGER SHALL BE HDPE. BELOW 12-INCH DIAMETER SHALL BE PVC SDR-35 ASTM D3034. PRIVATE WATER MAIN SHALL BE CLASS 150 DR 18 PVC CONFORMING TO AWWA C-900. PRIVATE SANITARY SEWER SHALL BE PVC SDR-35 ASTM D3034.
9. COORDINATE FINAL LOCATION AND DESIGN OF PRIVATE UTILITY SERVICES (ELECTRIC, GAS, PHONE, CABLE) WITH UTILITY COMPANIES.
10. IF PROJECT IS DESIGN BUILD MEP, THE GENERAL CONTRACTOR IS REQUIRED TO PROVIDE FINAL SEWER AND WATER DESIGN SHOWING LOCATION, INVERTS AND SIZES TO THE ENGINEER FOR FINAL REVIEW AND VERIFICATION PRIOR TO STARTING UNDERGROUND UTILITY CONSTRUCTION.

**SIGMA GROUP**  
Single Source. Sound Solutions.  
www.thesigmagroup.com  
1300 West Canal Street  
Milwaukee, WI 53233  
Phone: 414-643-4200  
Fax: 414-643-4210

**PROJECT TITLE**  
LOCATION  
ADDRESS  
ACAD, WISCONSIN

**EXISTING VETERANS PARK UTILITIES**

|   |         |
|---|---------|
| NO. REVISION                                  | DATE BY |
|   |         |
| DRAWING NO. 16270-VETERANS PARK UTILITIES.dwg |         |
| DRAWN BY:                                     |         |
| DATE:   |         |
| PROJECT NO:                                   |         |
| CHECKED BY:                                   |         |
| APPROVED BY:                                  |         |
| SHEET NO.:                                    |         |
| <b>C 300</b>                                  |         |





**Figure 2**  
Topography and Storm Sewer System

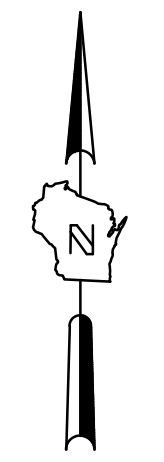



GRAPHIC SCALE  
0 200' 400'

**LEGEND**

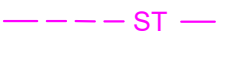
-  OUTFALL
-  CATCH BASIN
-  MANHOLE
-  ST STORM SEWER

**EXISTING VETERANS PARK UTILITIES**



CALL DIGGERS HOTLINE  
1-800-242-8511  
TOLL FREE  
WE DIGGER RESPONSIBLY  
REQUIRED BY 2 WISE LAYS  
MAYBE WHERE YOU DIG  
MILW. AREA 259-1181

THE UNDERGROUND UTILITY INFORMATION SHOWN ON THIS MAP IS BASED ON FIELD MARKINGS AND INFORMATION FURNISHED BY UTILITY COMPANIES AND THE LOCAL MUNICIPALITY. WHILE THIS INFORMATION IS BELIEVED TO BE RELIABLE, ITS ACCURACY AND COMPLETENESS CANNOT BE GUARANTEED.



**Figure 3**  
Greenprint for Milwaukee Shoreline-Phase 1 Details

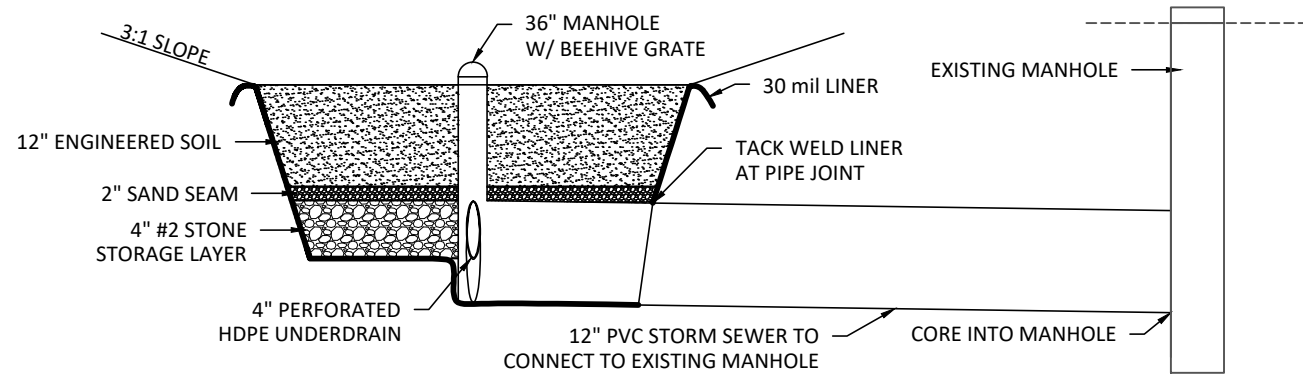

BIORETENTION CROSS-SECTION

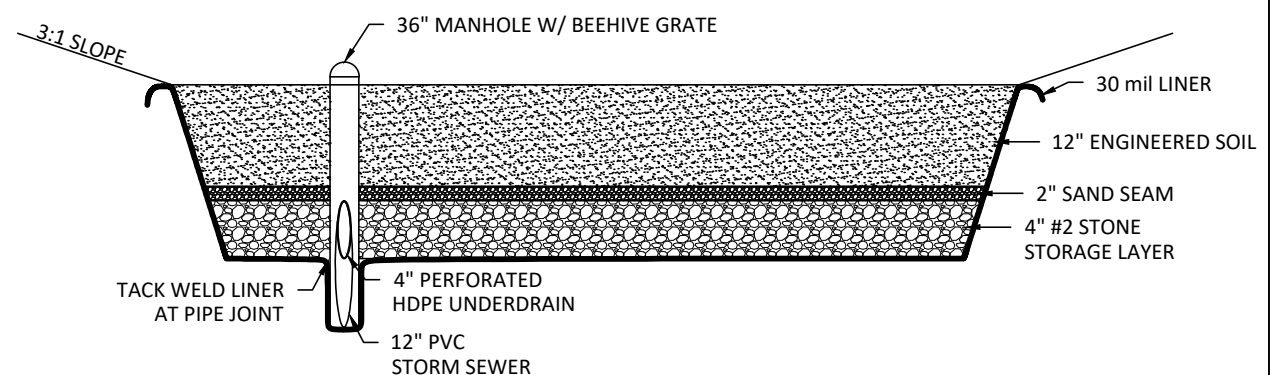

BIORETENTION PROFILE

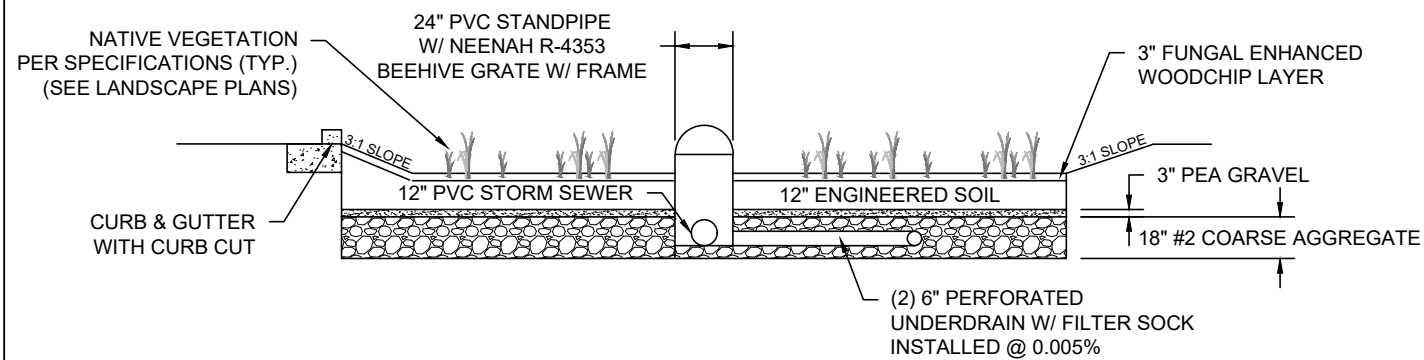

BIORETENTION W/ CURB CUT

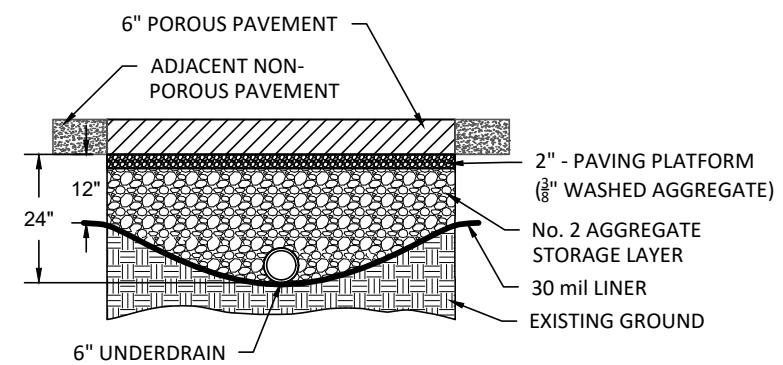

POROUS PAVEMENT CROSS-SECTION

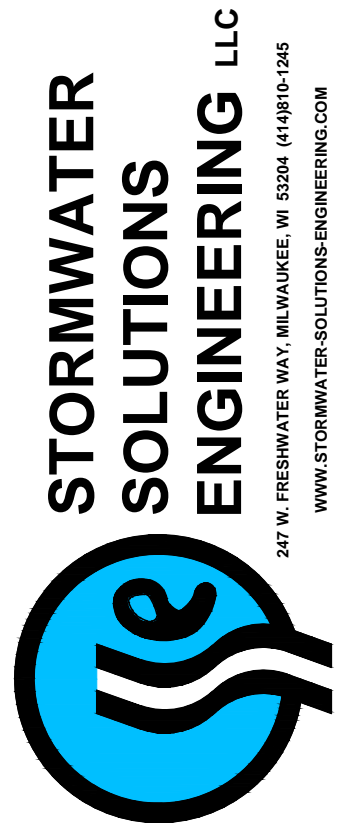

**STORMWATER SOLUTIONS ENGINEERING LLC**

247 W. FRESHWATER WAY, MILWAUKEE, WI 53204 (414)810-1245  
WWW.STORMWATER-SOLUTIONS-ENGINEERING.COM

GREENPRINT FOR MILWAUKEE

SHORELINE - PHASE 1

MILWAUKEE COUNTY WAR MEMORIAL, INC.

750 N. LINCOLN MEMORIAL DRIVE

MILWAUKEE, WI 53202

DATE: APR, 2017

DWG BY: HJG

CHK'D BY: ARC

APRV'D BY: CBG

GREEN INFRASTRUCTURE DETAILS

SHEET #  
**1**

NOT TO SCALE

**Figure 4**  
Parking Concept A



# PARKING OPTION A (MAINTAIN EXISTING VEHICULAR ENTRANCE AT CURRENT LOCATION)

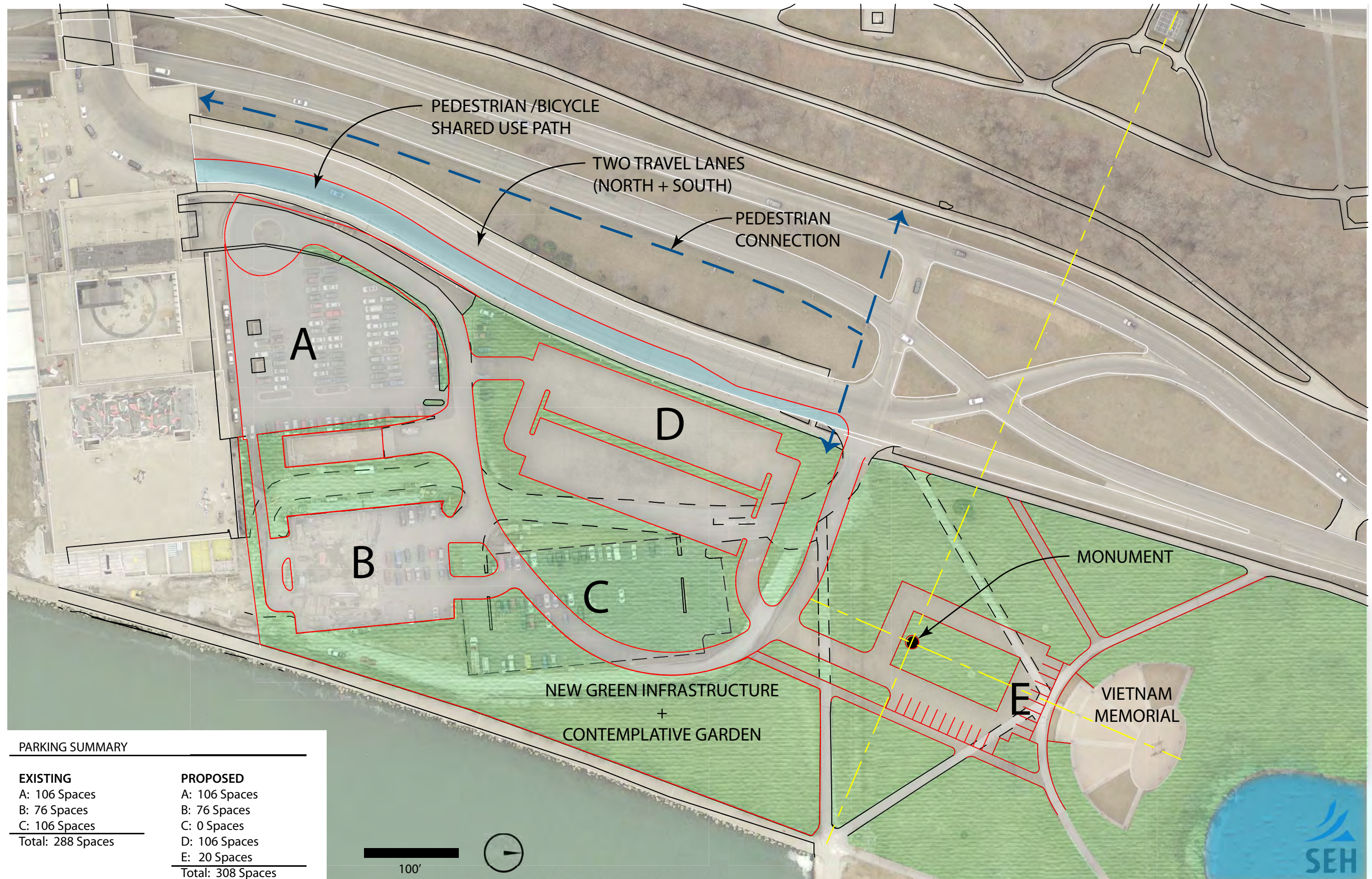

NOTE: Future 2nd Parking Level On "D" Yields An Additional 100 Cars



**Figure 5**  
Parking Concept A – Pedestrian Connections



# PARKING OPTION A PEDESTRIAN CONNECTIONS

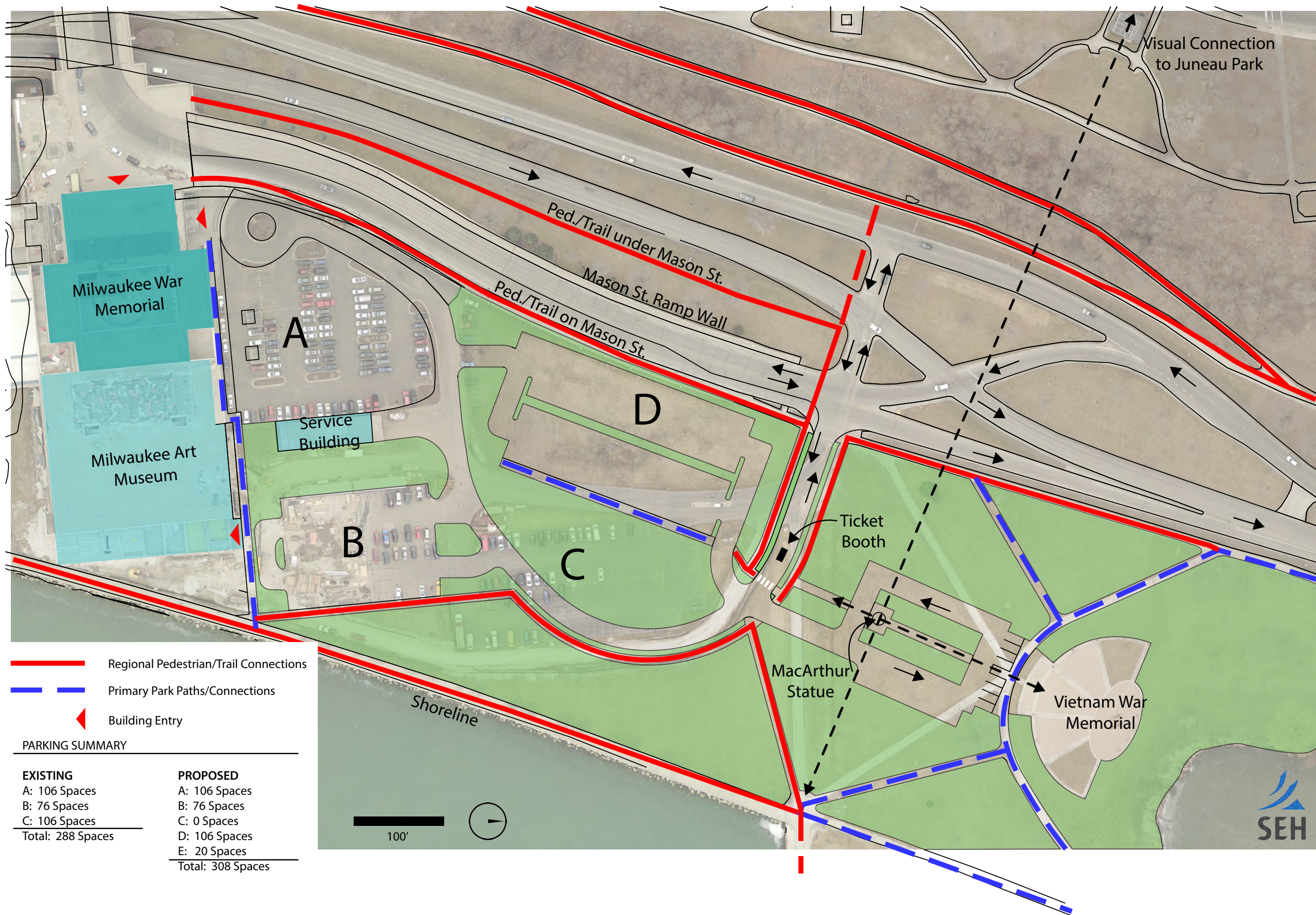

- Regional Pedestrian/Trail Connections
- Primary Park Paths/Connections
- ◀ Building Entry

**PARKING SUMMARY**

| EXISTING                 | PROPOSED                 |
|--------------------------|--------------------------|
| A: 106 Spaces            | A: 106 Spaces            |
| B: 76 Spaces             | B: 76 Spaces             |
| C: 106 Spaces            | C: 0 Spaces              |
| <b>Total: 288 Spaces</b> | D: 106 Spaces            |
|                          | E: 20 Spaces             |
|                          | <b>Total: 308 Spaces</b> |

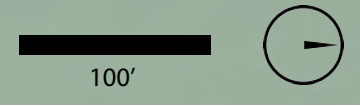
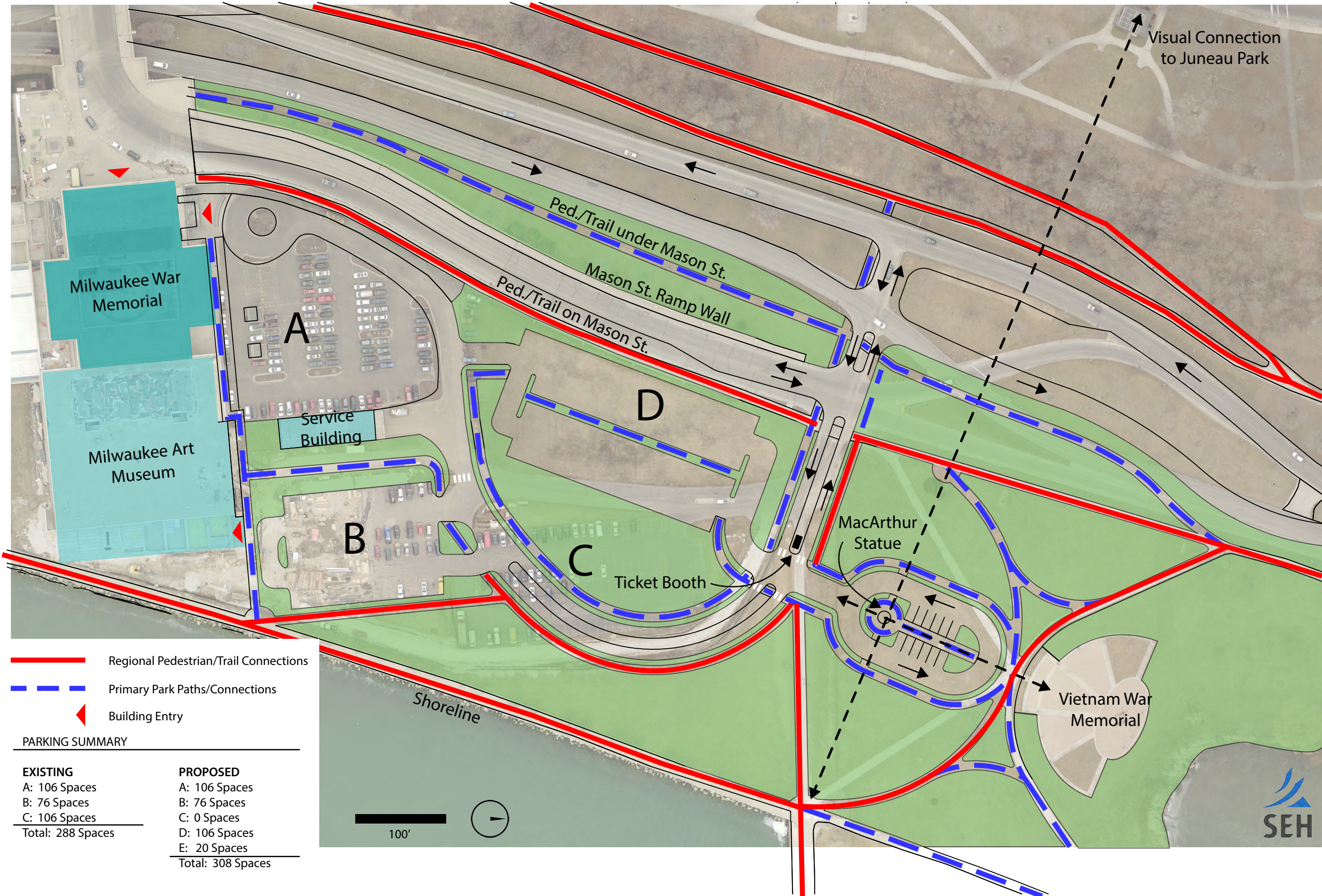



**Figure 6**  
Parking Concept A.2 – Pedestrian Connection



# PARKING OPTION A.2 PEDESTRIAN CONNECTIONS



- Regional Pedestrian/Trail Connections
- - - Primary Park Paths/Connections
- ◀ Building Entry

**PARKING SUMMARY**

| EXISTING                 | PROPOSED                 |
|--------------------------|--------------------------|
| A: 106 Spaces            | A: 106 Spaces            |
| B: 76 Spaces             | B: 76 Spaces             |
| C: 106 Spaces            | C: 0 Spaces              |
| <b>Total: 288 Spaces</b> | D: 106 Spaces            |
|                          | E: 20 Spaces             |
|                          | <b>Total: 308 Spaces</b> |



**Figure 7**  
Phase 1 – Concept B



# PARKING OPTION B (MOVE VEHICULAR ENTRANCE NORTH)

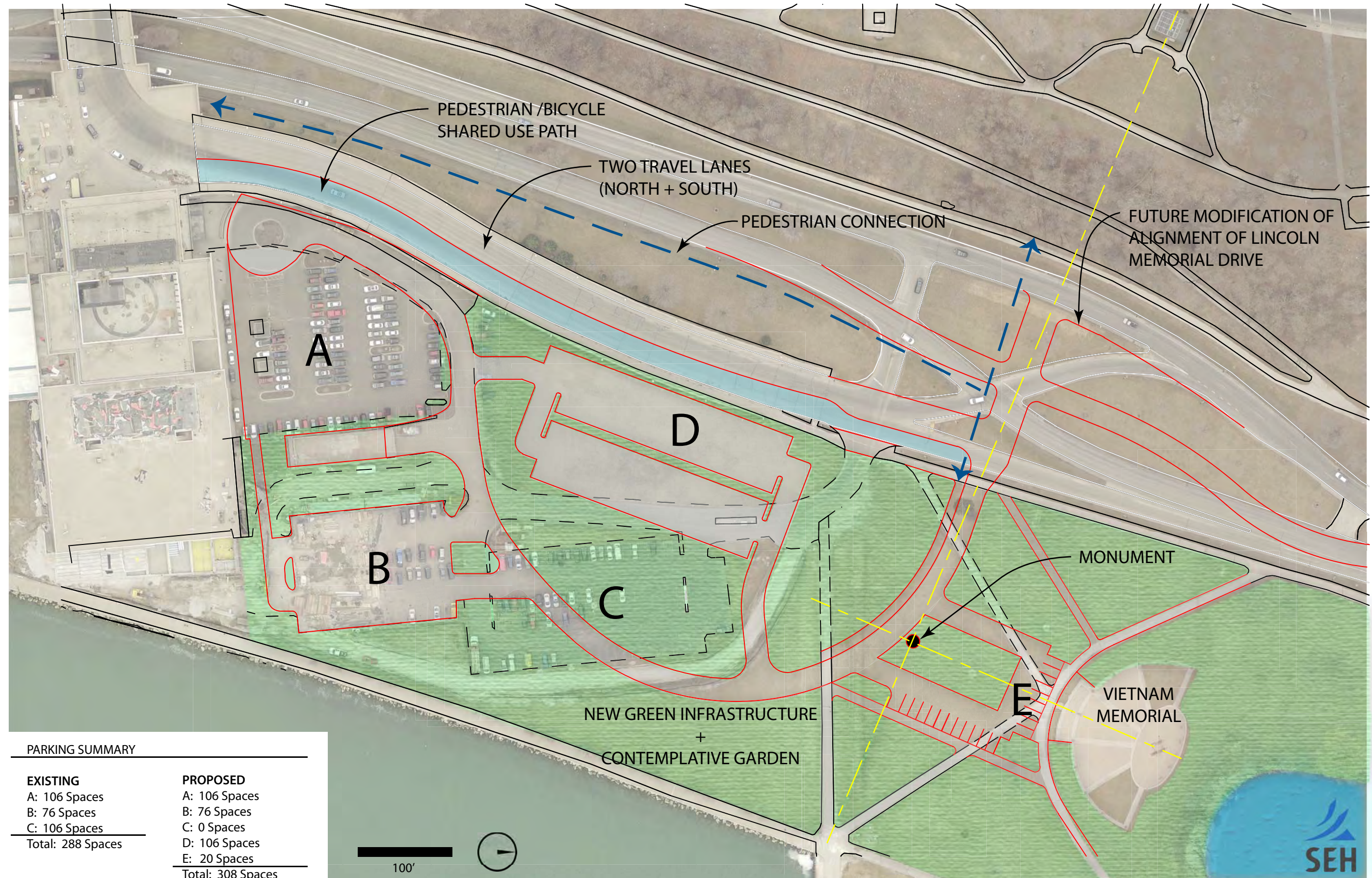

NOTE: Future 2nd Parking Level On "D" Yields An Additional 100 Cars



**Figure 8**  
Phase 1 – Concept C



# FUTURE OPTION C (OPTION B + LAGOON ENHANCEMENTS)

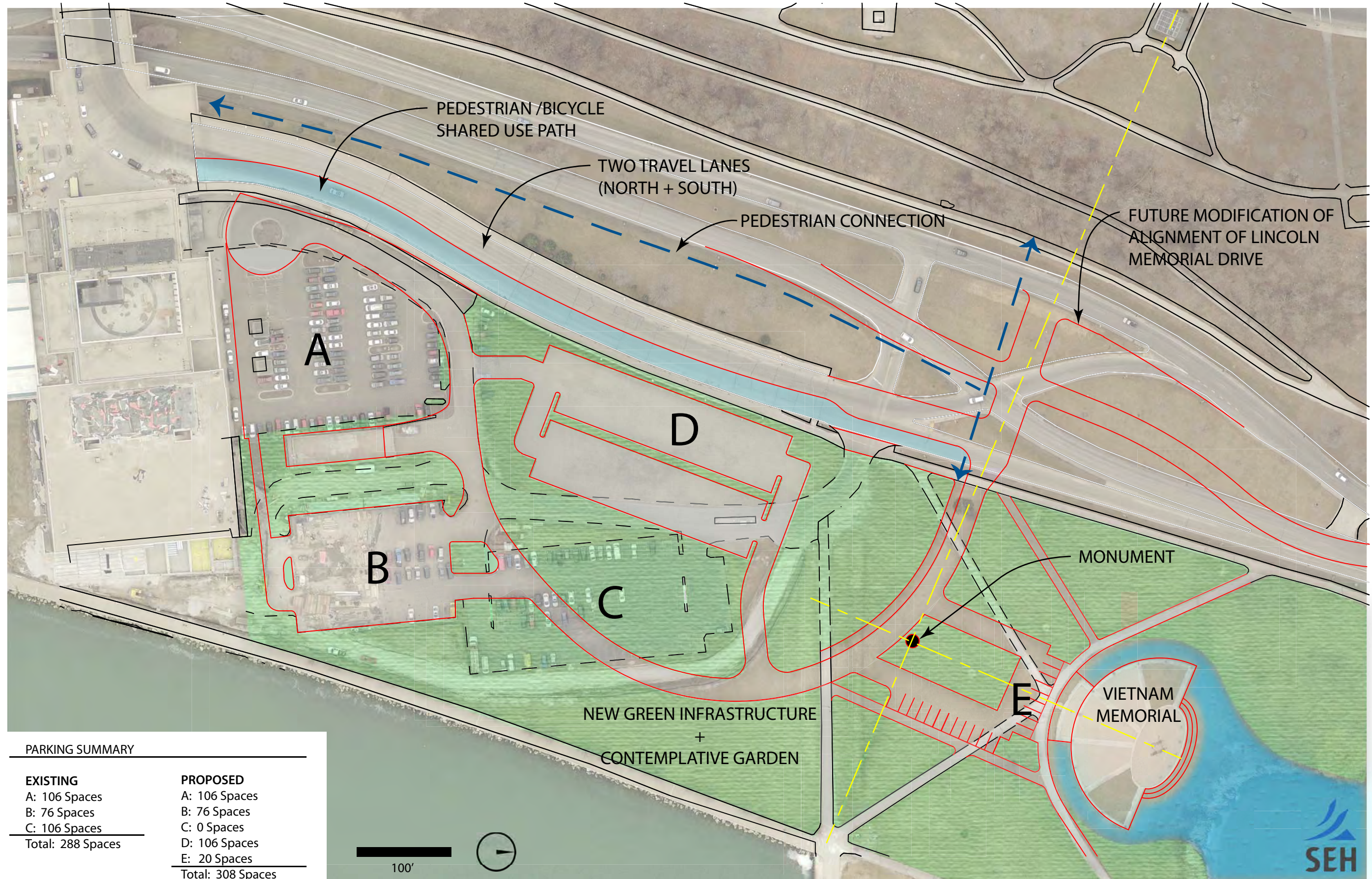

NOTE: Future 2nd Parking Level On "D" Yields An Additional 100 Cars



**Figure 9**  
Rendering – Looking South-West







**Figure 10**

Rendering – Looking North along promenade





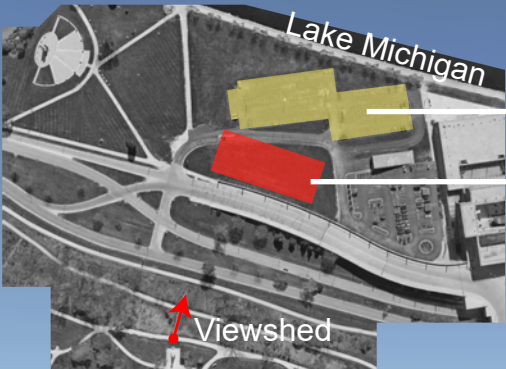

**Figure 11**

Rendering – Looking East from bluff



# PARKING LOT LOCATIONS



- Existing lot visible over the Mason Street ramp
- Proposed lot unseen from Juneau Park, hidden by Mason Street ramp





**Appendix A**  
Stakeholder List



# Greenprint Stakeholders

| Organization                       |   | Contact                                   | Stakeholder Meeting #1 | Workshop                  | Stakeholder Meeting #2    | Public Meeting        |
|------------------------------------|---|---|------------------------|---------------------------|---------------------------|-----------------------|
| <b>War Memorial Center Tenants</b> |   |   | <i>July 14, 2016</i>   | <i>September 14, 2016</i> | <i>September 29, 2016</i> | <i>March 14, 2017</i> |
|                                    | AMVETS                                      |   |                        |                           |                           |                       |
|                                    | Chipstone Foundation                        | Jackie Sarich                             |                        |                           |                           |                       |
|                                    | Dry Hootch                                  | Bob Curry                                 |                        |                           |                           |                       |
|                                    | Horizon/Rotary Club of Milwaukee            | Phil Schultz                              | X                      | X                         |                           |                       |
|                                    | International Assn. for Orthodontics        | Detlef Moore                              | X                      |                           | X                         |                       |
|                                    | Kiwanis                                     | Julie Gmeinder                            |                        |                           | X                         |                       |
|                                    | Marjorie Stewart                            | Marjorie Stewart                          |                        |                           |                           |                       |
|                                    | Milwaukee Art Museum                        | Jane Wochos                               | X                      | X                         |                           |                       |
|                                    | Milwaukee Church of Christ                  | Kristin Pratt                             |                        |                           |                           |                       |
|                                    | Rotary Club of Milwaukee                    | Mary McCormick                            | X                      | X                         |                           | X                     |
|                                    | USO   | Josh Sova                                 |                        |                           | X                         |                       |
|                                    | War Memorial Center                         | David Drent                               | X                      | X                         | X                         | X                     |
|                                    | War Memorial Center                         | Vicki Chappell                            | X                      | X                         | X                         | X                     |
|                                    | War Memorial Center                         | Laurie Kildegaard                         | X                      |                           |                           |                       |
|                                    | War Memorial Center                         | Jennifer Wallner                          | X                      |                           |                           |                       |
|                                    | War Memorial Center                         | Mark Walgreen                             | X                      |                           |                           |                       |
|                                    | War Memorial Center                         | Peter Pochowski                           | X                      | X                         |                           |                       |
| <b>Gateway &amp; Downtown</b>      |   |   |                        |                           |                           |                       |
|                                    | 89.7 FM WUWM                                | Susan Bence                               |                        |                           |                           |                       |
|                                    | African American Chamber                    | Eve Hall                                  |                        |                           |                           |                       |
|                                    | Betty Brinn Children's Museum               | Fern Shupack                              |                        |                           |                           | X                     |
|                                    | Beyond Vision                               | Jim Kerlin                                |                        |                           | X                         |                       |
|                                    | Brady Street BID                            | Steph Salvia                              |                        |                           |                           |                       |
|                                    | Business Improvement District               | Elizabeth Weirick, Executive Director     |                        |                           |                           |                       |
|                                    | City of Milwaukee DCD                       | Greg Patin                                |                        | X                         | X                         |                       |
|                                    | City of Milwaukee DCD                       | Rocky Marcoux, Commissioner for City Dev. |                        |                           |                           |                       |
|                                    | City of Milwaukee DPW                       | Karen Dettmer                             | X                      | X                         |                           | X                     |
|                                    | Discovery World                             | Joel Brennan                              |                        |                           | X                         |                       |
|                                    | Discovery World                             | Jennifer Clearwater, CFRE                 |                        |                           |                           |                       |
|                                    | East Town Association                       | Kim Morris                                |                        |                           |                           |                       |
|                                    | Harbor District, Inc.                       | Lilith Fowler                             |                        |                           |                           |                       |
|                                    | Harbor House                                | Christian Damiand                         |                        |                           |                           | X                     |
|                                    | Historic Third Ward Association             | Stephanie Sherman                         |                        |                           |                           |                       |
|                                    | Metro Milwaukee Association Commerce (MMAC) | Corry Biddle                              |                        |                           |                           |                       |
|                                    | Milwaukee Art Museum                        | Dan Somers, Facilities                    | X                      |                           | X                         |                       |
|                                    | Milwaukee DCD (Bike-Ped)                    | Kristin Bennett                           |                        |                           |                           |                       |
|                                    | Nelson-Schmidt                              | Dan Nelson                                |                        |                           | X                         |                       |
|                                    | Northwestern Mutual                         | Kevin Kennedy                             |                        |                           |                           |                       |
|                                    | Summerfest                                  | Bob Gosse                                 |                        |                           | X                         | X                     |
|                                    | Visit Milwaukee                             | Paul Upchurch                             |                        |                           |                           |                       |
|                                    | Wisconsin DNR-Lakeshore State Park          | Tom Kroeger (Lakeshore State Park)        |                        |                           | X                         |                       |
| <b>Park Users</b>                  |   |   |                        |                           |                           |                       |
|                                    | Friends of Lakeshore Park                   | Sue Frautschi                             |                        |                           | X                         |                       |
|                                    | Fund for Lake MI                            | Vicki Elkin                               | X                      | X                         |                           |                       |
|                                    | Jewish Museum                               | Patti Sherman-Cisler, Executive Director  |                        |                           |                           |                       |
|                                    | Juneau Park Friends                         | Lisa Hatch/Mick Hatch                     |                        |                           | X                         | X                     |
|                                    | Juneau Park Friends                         | Emilee Walter                             |                        |                           |                           | X                     |
|                                    | Lakefront Development Advisory Commission   | Bill Lynch                                |                        |                           | X                         |                       |
|                                    | MCTS  | Brendan Conway                            |                        |                           |                           |                       |
|                                    | Milwaukee Community Sailing Center          | Jamie Bargaquas                           |                        |                           |                           | X                     |
|                                    | Milwaukee Community Sailing Center          | Karen Hunt                                |                        |                           | X                         | X                     |
|                                    | Milwaukee County                            | Jeremy Theis                              |                        |                           |                           |                       |
|                                    | Milwaukee County                            | Sheldon Wasserman                         |                        |                           |                           |                       |
|                                    | Milwaukee County                            | Jason Haas                                |                        |                           |                           |                       |
|                                    | Milwaukee County DAS                        | Julie Bastin                              |                        | X                         | X                         | X                     |
|                                    | Milwaukee County Parks                      | Kevin Haley                               | X                      | X                         | X                         | X                     |
|                                    | Milwaukee County Parks                      | John Dargle                               |                        |                           |                           | X                     |
|                                    | Milwaukee River Keeper                      | Cheryl Nenn                               |                        |                           |                           | X                     |
|                                    | Milwaukee River Keeper                      | Jennifer Breceda                          |                        |                           |                           |                       |
|                                    | Milwaukee Yacht Club                        | Tom Maliszko                              |                        |                           | X                         |                       |
|                                    | MMSD  | Bre Plier                                 | X                      | X                         |                           |                       |
|                                    | MMSD  | Lisa Sasso                                |                        |                           | X                         |                       |
|                                    | Park People of Milwaukee County             | Jim Goulee                                |                        |                           |                           |                       |
|                                    | Parks People                                | Charlie Kamps                             |                        |                           |                           | X                     |
|                                    | Parks People                                | Eddee Daniel                              |                        |                           |                           |                       |
|                                    | Parks People                                | Gerry Broderick                           |                        |                           |                           |                       |
|                                    | Port of Milwaukee                           | Larry Sullivan                            |                        |                           | X                         |                       |
|                                    | South Shore Yacht Club                      | Karl Kruger                               |                        |                           |                           | X                     |
|                                    | Wisconsin Coast Management                  | Todd Breiby                               |                        |                           |                           |                       |
|                                    |   | John Lunz                                 |                        |                           |                           |                       |
|                                    |   | Bill Hibbard                              |                        |                           |                           |                       |
| <b>Veterans</b>                    |   |   |                        |                           |                           |                       |
|                                    | Veterans Board of Directors                 | Patrick Romero                            |                        |                           |                           |                       |
| <b>Public</b>                      |   |   |                        |                           |                           |                       |
|                                    |   | Bill Mollenhauer                          |                        |                           |                           | X                     |
|                                    | The Sigma Group                             | Mike Morgan                               |                        |                           |                           | X                     |



**Appendix B**  
Workshop Outcome





← → PEDESTRIAN / BIKE

Circulation





## Greenprint Options

Greenprint  
Summary Drawing 9.14.16 Workshop





## Programming



**Appendix C**  
Stakeholder Meeting #2 Notes





## MEETING MINUTES

### SHORELINE MASTERPLAN

#### Stakeholder Meetings

Session 1: 9:30 – 11:00 am

Thursday, September 29, 2016

Milwaukee County War Memorial, N Lincoln Drive, 4<sup>th</sup> Floor, Room 411

#### Attendees:

David Drent – War Memorial Center  
Vicki Chappell – War Memorial Center  
Detlef Moore – International Assn. for  
Orthodontics  
Julie Gmeinder – Kiwanis  
Josh Sova – USO  
Dan Summers – Milwaukee Art Museum

Bill Lynch – Lakefront Development Advisory  
Commission  
Jim Kerlin – Beyond Vision  
Ed Freer – SHE  
Bob Pecshel – Sigma  
Karen Springob – SSE  
Alyssa Schmitt - SSE

#### Introduction:

- Ed Freer gave an introduction to the project and why the park is being assessed as a whole, how development has occurred to this point (Greenprint Workshop Handout), the intent of this meeting, the implementation plan, creating a masterplan, more inclusive stakeholder meetings and public meetings, and then presented and explained the concept/greenprint plans (Alpha, Bravo, & Charlie) and opened it to stakeholder input.

#### Stakeholder Conversation:

- Can currently sail within the breakwall and islands or wall could intrude with that
- One user assumed the stormwater outfalls went directly to deep tunnel. May want to clarify.
- Lighting at walls. Need navigational tools on all obstructions. – power boat driver concerns (No speed limit at this time)
- Kayakers have other lagoon and river
- Water circulation and sediment settlement
  - Have good understanding of sediment transport (dredging problem)
- Wave seiche acts like a tide when high and low weather fronts combine on a long stretch of beach.
- Rotary/Yacht Club: sequence of exit/enter – traffic patterns/studies – not controlled. 500 cars during large events.
- Out of towners going to Art Museum or WM – confusion with driving away from destination
- The current “spaghetti” roadway pattern has people driving the wrong direction.
- Concerns with adding roadways and pavement to where there currently is not
  - Not in favor/less desirable
  - Enjoys the park-like setting





- Considerations to Mason Ramp
  - Lots of space to work with
  - Functions like a freeway
  - Can we close? North/South (Lincoln Memorial) travelers would oppose closing.
  - Is it possible to keep what is existing, eliminate parallel parking and use remaining pavement for pedestrians and bike users?
- Start with “greening up” parking lot to north and adding stormwater improvements, but in context of master plan – little piece of a big plan. How will other improvements be funded.
- Ed clarified that one of the funders needs to see the master plan, as they are not in favor of funding a “parking lot”.
- Surface parking is less desirable in scarce land. Can multi level parking solutions be used (hydraulic lifts)?
- #1 focus – do best to manage stormwater while improving parking lot
  - Not in favor of parking under Mason St Bridge
- Lagoon Drive takes up significant green space, but provides options if you miss first driveway.
- Charlie formalizes entry way to WM
- DOT study on Mason Street? Is this maybe an entrance to the City from the south? The city does not like closing roads.
- Vietnam War Memorial Room does not move
- Signage to find your way to WM or AM
  - People already drive past
  - Very confusing intersection
  - Especially dangerous leaving during peak traffic times (ie 5pm)
  - Bicycles come down hill at dangerous speeds.
- **RECOGNIZE BUILDING & ENTRANCE OF WM**
- Permeable Pavement in north parking lot (Rotary Club)
  - Can we use different stormwater measures
- Infiltration into fill = bad
- Issues with fill in project location. Some of fill contains PAH (chemical in asphalt binder), and this is of great concern with regards to infiltration.
- The lighthouse may be fixed up, and used for events. People will potentially park, catch a boat, and party at lighthouse.
- Instead of more parking, what about a shuttle service, car raising/valet service in stead of capital infrastructure.
- Tenant not fond of hydraulic lift
  - Fear
  - Cost of parking increase
- Charge for surface parking? Salt and oil going straight to the lake.
- Alternative Bravo is preferred for gaining more green space.
- Question raised regarding the life span of a bioswale? It will require maintenance.
- Runoff concern – want to do good SW treatment at the parking lot
- Concepts are not mutually exclusive
- Special event space to remain (park space where events take place)
- Cost Estimates to come when plan develops





**STORMWATER  
SOLUTIONS  
ENGINEERING LLC**

- WQ concerns from opening lagoon
- Maintenance of SW BMP techniques
- Maintenance of Islands or “walls”
- Integrated short term parking. Existing and future parking lot uses should be discussed.
- Trash problem – removal of 90 degree corners where trash collects
- WM Board is dedicated to “doing the right thing” regarding SW

**Poster Notes (Ed):**

- Boating space reduce
- Navigational aids
- Sedimentation
- Sequencing of entrance
  - Traffic stops
  - Adding pavement to park land
- Can you change the Mason Ramp
- Best BMP – Ample Parking
- Signage
- Can we use permeable pavement
- Lighthouse = Purchased Parking
- Cost of parking lifts from user perspective
- Maintenance of biofilter
- Incorporate short term drop

Drafted by ABS, 09/30/2016





## MEETING MINUTES

### SHORELINE MASTERPLAN

#### Stakeholder Meetings

Session 2: 1:00 – 2:30 pm

Thursday, September 29, 2016

Milwaukee County War Memorial, N Lincoln Drive, 4<sup>th</sup> Floor, Room 411

#### Attendees:

Jen Clearwater – Discovery World  
Tom Kroeger – Lakeshore State Park  
Bob Gosse – Summerfest  
Greg Patin – City of Milwaukee DCD

Dan Nelson – Nelson-Schmidt  
Ed Freer – SEH  
Bob Peshel – Sigma  
Karen Springob – SSE

#### Introduction:

#### Stakeholder Conversation:

- The Gateway – “Way Finding”, branding signage.
- Minutes to walk, digital sign?
- Can we retrofit parking lot under Mason St?
- Like the walkability with the islands and veteran “stops”
- Too much roadway proposed with plan B and C
- Too many stops. Clybourn, Michigan and now these extra proposed signals.
- Mid-entry in Alternative Charlie is a nice “experience”, but too much park space is lost.
- Happy that the rocky brow (near AM) will go away, islands would be good alternative.
- Bridges can have water overtop path or bridge.
- May be a struggle with navigability between islands.
- Lake is 17’ deep near promenade.
- Cattails are problematic. Concerned about vegetation to be planted and maintained within created wetlands.
- Pollinator Pathway – there is a 40% loss in bug populations within urban areas, and a 90% loss in suburbs.
- Bring islands inside of pedestrian pathway.
- Nor’easter can cause unobstructive waves in this area.
- Transient mooring field – not opposed to idea
- How to get the “low hanging fruit”
  - Eliminate right angles, trash collector geometry
  - Cleaning up stormwater
  - A Master Plan is good
- Alternative Alpha appealing with retaining wall that will eliminate the “goofy” hill. Awkward area.
- Is bike path addressed?





**Poster Notes (Ed):**

- Pollenator paths
- Bring in islands – behind breakwater
- Kayak/Paddle experiences around islands
- Alpha + Charlie
- Hanging trash bays
- Added pavement = negative
- Mason Street Bridge Conflict
- Charlie
- Wading to island
- Wider trail along land around lagoon
- Cat tails take over

Drafted by KSS, 09/30/2016





## MEETING MINUTES

### SHORELINE MASTERPLAN

#### Stakeholder Meetings

Session 3: 3:00 – 4:30 pm

Thursday, September 29, 2016

Milwaukee County War Memorial, N Lincoln Drive, 4<sup>th</sup> Floor, Room 411

#### Attendees:

Lisa Hatch – Juneau Park Friends  
Sue Frautschi – Lakeshore Park  
Julie Bastin – Milwaukee County DAS  
Kevin Haley – Milwaukee County Parks  
Karen Hunt – Milwaukee Sailing Center  
Lisa Sasso – MMSD

Larry Sullivan – Port of Milwaukee  
Tom Maliszko – Milwaukee Yacht Club  
Ed Freer – SEH  
Bob Peshel – Sigma  
Alyssa Schmitt - SSE

#### Introduction:

- Ed Freer gave an introduction to the project and why the park is being assessed as a whole, how development has occurred to this point (Greenprint Workshop Handout), the intent of this meeting, the implementation plan, creating a masterplan, more inclusive stakeholder meetings and public meetings, and then presented and explained the concept/greenprint plans (Alpha, Bravo, & Charlie) and opened it to stakeholder input.

#### Stakeholder Conversation:

- Goat path needs to be fixed
- First – safety concerns need to be considered
- Make Mason St Bridge have an actual bike path
  - Perhaps raise or separate bike path from road
- *Mason St is here to stay*
- Prospect/Juneau Bluff – enhance aesthetic lookout
  - Improve view from the upland
- *Bridge could possibly have parking lot*
- Connecting to water you see two rows of parking
  - Could use vines for wall
- No extra vehicular traffic
  - Sense of “invasion”
  - Source of pollution
- Concerns from traffic coming in and inflow of parking
  - *Only plus/minus 300*
- In favor of connection from lagoon to lake should allow paddle boats and kayaks
- Favor view of Veteran’s Memoria (enhance)
  - *Huge opportunity to create a setting*
- Not necessarily increasing traffic or “adding” just changing the entrance
- Visitor parking or employees





- Like Bravo and Charlie for wider space to protect and buffer lake – positive tradeoff to protect Lake Michigan
- Control of waves
- If you add access from Lagoon to the Lake, especially via south, almost need protection buffers/breaks
- Charlie Lagoon encroaches on land where lots events take place
- Variety could enhance boater experience—“coastal experience”
- Management challenges with kayakers and changing waters
- Limitations of dangerous access
- Signage for motorized craft
- Recreational beaches
- Juneau Park connection
  - Do not make freeway connection
  - Would bridge turn park into “hallway”
- Juneau wants connection – bluff is dangerous
  - Wants connection but not a thoroughfare
  - Do not send people down bluff into spaghetti bowl
- Larger buffer – less noise
- Moving Lagoon offers better trees/organic/creativity
- Moving ski shows, etc to protected bay
- Better treat water coming off of North Parking Lot
- Enhanced promenade
  - Improve pavement
  - Add seating
  - “Detroit Riverwalk”
- Clever detailing for “edges” with plantings
- “Sunday stroll in the park”
- Vegetation for separation
- Would you want to create better areas for kayaks, kites, fishing
- Like casual water sports
- Next steps = adding spots for playgrounds, bocci ball, etc
  - Will get transposed to draft plan
- Need to enhance pedestrian traffic on North end
  - Kevin is pushing for it!
  - Desired for connection
- Enhancement around boatyard/Milwaukee Sailing Center
  - Black picket fencing instead of chain link
- Next steps: Contact – Public Release
- How can we look at this whole instead of after thoughts
- Plan – Costs – Funding – Budget
- Crucial: Pedestrian Traffic

**Poster Notes (Ed):**

- Goat path need to be fixed
- Safety issues (first)
- View from upland
- Quiet on east side at Lagoon





- Overgrown shoreline – better view of Veterans Memorial
- Varied Shoreline

Drafted by ABS, 09/30/2016